



TRABAJAMOS POR SU SEGURIDAD
WE WORK FOR YOUR SAFETY
NOUS TRAVAILLONS POUR VOTRE SÉCURITÉ



CLS 
INSPIRAMOS A SUA SEGURANÇA

www.productosclimax.com
MADE IN SPAIN

EQUIPOS DE PROTECCIÓN INDIVIDUAL
PERSONAL PROTECTIVE EQUIPMENT
EQUIPEMENT DE PROTECTION INDIVIDUELLE

2022
2023

LA EMPRESA | COMPANY | LA SOCIÉTÉ

Productos Climax es uno de los principales fabricantes de equipos de protección individual, con un amplio catálogo que abarca todos los ámbitos de trabajo.

Creada en 1984, Productos Climax ha ido creciendo gracias a la experiencia y el know-how adquirido durante todos estos años que le han permitido, por un lado, ofrecer siempre un producto adaptado a las necesidades de nuestros clientes y usuarios y, por otro, afrontar las complejidades de los mercados nacional e internacional.

Bajo el lema "trabajamos por su seguridad", Productos Climax aplica su cultura empresarial en cada uno de sus procesos de fabricación, para ofrecer un producto que garantice la máxima seguridad y comodidad a sus usuarios y cumpla con los requisitos técnicos exigidos por la normativa CE y con los requerimientos establecidos en ley.

El departamento técnico de la empresa, diseña y desarrolla los EPI Climax, en función de las necesidades de cada trabajo específico, que son fabricados bajo un severo control de calidad, posteriormente verificada en laboratorios propios y en los de homologación oficiales, para obtener el certificado correspondiente.

Productos Climax is one of the main PPE manufacturers, with a large catalogue including all work areas.

The experience and the "know-how" acquired since Productos Climax was born in 1984, have permitted us to offer a product adapted to our customers needs in one hand, and to face the constant complexities of national and international markets.

Under the slogan "we work for your safety". Productos Climax applies its corporate culture at each manufacturing process, to offer a product that guarantees the highest quality and confort to users, and to comply the technical requirements demanded by CE standards and those established by law.

Our PPE are designed and developed by our technical department, depending on the needs of each specific work, under a very strict quality control and verified at our own laboratories and at official homologation ones to obtain the corresponding certification.

Productos Climax est un des principaux fabricants des équipes de protection individuelle, avec un vaste catalogue qui couvre tous les secteurs du travail.

L'expérience et le savoir faire acquis depuis sa création en 1984, nous ont permis d'offrir un produit adapté aux besoins de nos clients, d'un côté, et de faire face aux complexités des marchés aussi bien nationaux qu'internationaux, de l'autre.

Sous le slogan "nous travaillons pour votre sécurité", Productos Climax applique sa culture d'entreprise dans chaque un des processus de fabrication, pour offrir un produit avec la plus grande sécurité et le plus grand confort aux utilisateurs, et répondant aux exigences techniques établies para la norme CE et fixées par la loi.

Tous nos équipes sont conçus et développés par notre Service Technique, en fonction des besoins de chaque travail spécifique, sous une sévère contrôle qualité et vérifiés par la suite dans nos propres laboratoires et les centres officiels d'Homologation pour obtenir le certificat correspondant.



PROTECCIÓN RESPIRATORIA
RESPIRATORY PROTECTION
PROTECTION RESPIRATOIRE



PROTECCIÓN CONTRA CAÍDAS
FALL PROTECTION
PROTECTION ANTI CHUTES

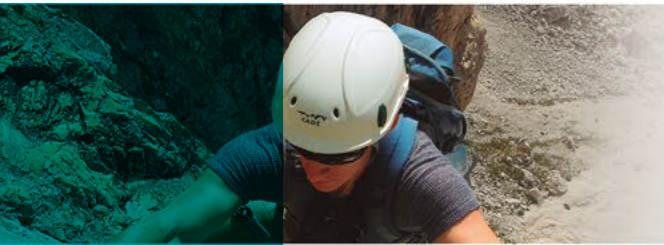

PROTECCIÓN DE LA CABEZA
HEAD PROTECTION
PROTECTION DE LA TÊTE



PROTECCIÓN FACIAL Y OCULAR
FACE AND EYE PROTECTION
PROTECTION DES YEUX ET DU VISAGE



PROTECCIÓN EN SOLDADURA
WELDING PROTECTION
PROTECTION SOUDURE



PROTECCIÓN AUDITIVA
HEARING PROTECTION
PROTECTION AUDITIVE



PROTECCIÓN DEL CUERPO
BODY PROTECTION
PROTECTION DU CORPS



PROTECCIÓN CONTRA ELECTRICIDAD ESTÁTICA
PROTECTIONS AGAINST STATIC ELECTRICITY
PROTECTION CONTRE L'ÉLECTRICITÉ STATIQUE



MATERIAL AISLANTE CON BAJA CONDUCTIVIDAD ELÉCTRICA
INSULATING MATERIAL WITH LOW ELECTRICAL CONDUCTIVITY
MATÉRIAU ISOLANT À FAIBLE CONDUCTIVITÉ ÉLECTRIQUE



MATERIAL RESISTENTE AL FUEGO O AL CALOR
MATERIAL RESISTANT TO FIRE OR HEAT
MATÉRIAU RÉSISTANT AU FEU OU À LA CHALEUR



CASCOS ELÉCTRICAMENTE AISLANTES
ELECTRICALLY INSULATING HELMETS
CASQUES ISOLANTS CONTRE LE RISQUE ELECTRIQUE



APARATOS Y SISTEMAS DE PROTECCIÓN PARA USO EN ATMÓSFERAS POTENCIALES EXPLOSIVAS
EQUIPMENT AND PROTECTIVE SYSTEMS INTENDED FOR USE IN POTENTIALLY EXPLOSIVE ATMOSPHERES.
DISPOSITIFS ET SYSTÈMES DE PROTECTION POUR UNE UTILISATION DANS DES ATMOSPHÈRES POTENTIELLEMENT EXPLOSIVES



SALPICADURA DE PRODUCTOS QUÍMICOS
CHEMICAL PRODUCT SPLASHES
RÉSISTANT AUX ECLABOUSSURES DE PRODUITS CHIMIQUES



ANTI IMPACTOS
ANTI IMPACTS
ANTI IMPACT



ANTI VAHO
ANTI FOG
ANTI-BUÉE



ANTI RALLADURAS
ANTI SCRATCHES
ANTI-RAYURES



CONTRA RADIACIONES
AGAINST RADIATIONS
CONTRE LES RADIATIONS

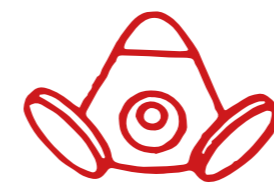

PROTECCIÓN RESPIRATORIA
RESPIRATORY PROTECTION
PROTECTION RESPIRATOIRE



» MÁSCARAS | FULL FACE MASK | MASQUES

PUNTOS DE ARNÉS | ANCHOR POINTS | POINTS HARNAIS

731-C



731-S





Resistente a impactos
Shockproof
Résistant aux chocs



Amplio rango de visión
Wide field of view
Large champ de vision



Resistente a rayaduras
Anti scratch
Résistant aux rayures

Estándar EN 148-1 / DIN 40
Standard EN 148-1 / DIN 40
Standard EN 148-1 / DIN 40

731	
Punto de arnés Anchor points Points harnais	5
Conexión filtro Filter threaded connection Lien filtre	Estándar EN 148-1
Filtros Filters Filtres	725
Material Material Matière	731-S = Silicona Silicona rubber Silicone 731-C = Caucho natural Natural rubber Caoutchouc
Factor de protección nominal (FP) Nominal protection factor (NPF) Facteur protection nominale (FPN)	1.000
Peso Weight Poids	580 gr
Norm	EN 136 EN 148-1 EN 166









Resistente a impactos
Shockproof
Résistant aux chocs



Amplio rango de visión
Wide field of view
Large champ de vision



Resistente a rayaduras
Anti scratch
Résistant aux rayures

Sistema bayoneta
Bayonet system
Système baïonnette

732-N	
Punto de arnés Anchor points Points harnais	5
Conexión filtro Filter threaded connection Lien filtre	Bayoneta Bayonet Baïonnette
Filtros Filters Filtres	757-N
Material Material Matière	Silicona Silicone rubber Silicone
Factor de protección nominal (FP) Nominal protection factor (NPF) Facteur protection nominale (FPN)	1.000
Peso Weight Poids	660 gr
Norm	EN 136 EN 166



» MASCARILLAS | HALF MASKS | DEMI-MASQUES

800	
Conexión filtro Filter threaded connection Lien filtre	Bayoneta Bayonet Baïonnette
Filtros Filters Filtres	757-N
Material Material Matière	TPE
Factor de protección nominal (FP) Nominal protection factor (NPF) Facteur protection nominale (FPN)	50
Peso Weight Poids	131 gr
Norm	EN 140



Sistema de fácil ajuste
Easy fitting system
Système de réglage facile

Cierre fácil
Easy lock system
Fermeture facile

MODELS
800 / 810 / 820

810	
Conexión filtro Filter threaded connection Lien filtre	Rosca Thread Filetage
Filtros Filters Filtres	755/756
Material Material Matière	TPE
Factor de protección nominal (FP) Nominal protection factor (NPF) Facteur protection nominale (FPN)	50
Peso Weight Poids	151 gr
Norm	EN 140



820	
Conexión filtro Filter threaded connection Lien filtre	Bayoneta Bayonet Baïonnette
Filtros Filters Filtres	757
Material Material Matière	TPE
Factor de protección nominal (FP) Nominal protection factor (NPF) Facteur protection nominale (FPN)	50
Peso Weight Poids	141 gr
Norm	EN 140





756	
Conexión filtro Filter threaded connection Lien filtre	Rosca Thread Filetage
Filtros Filters Filtres	755/756
Material Material Matière	Caucho termoplástico Thermoplastic rubber Caoutchouc thermoplastique
Factor de protección nominal (FP) Nominal protection factor (NPF) Facteur protection nominale (FPN)	50
Peso Weight Poids	152 gr
Norm	EN 140

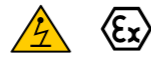

755	
Conexión filtro Filter threaded connection Lien filtre	Rosca Thread Filetage
Filtros Filters Filtres	755/756
Material Material Matière	Caucho termoplástico Thermoplastic rubber Caoutchouc thermoplastique
Factor de protección nominal (FP) Nominal protection factor (NPF) Facteur protection nominale (FPN)	50
Peso Weight Poids	129 gr
Norm	EN 140



761	
Conexión filtro Filter threaded connection Lien filtre	Rosca Thread Filetage
Filtros Filters Filtres	760
Material Material Matière	Caucho termoplástico Thermoplastic rubber Caoutchouc thermoplastique
Factor de protección nominal (FP) Nominal protection factor (NPF) Facteur protection nominale (FPN)	50
Peso Weight Poids	163 gr
Norm	EN 140



757-S	
Conexión filtro Filter threaded connection Lien filtre	Bayoneta Bayonet Baïonnette
Filtros Filters Filtres	757-N
Material Material Matière	Silicona Silicone rubber Silicone
Factor de protección nominal (FP) Nominal protection factor (NPF) Facteur protection nominale (FPN)	50
Peso Weight Poids	123 gr
Norm	EN 140



MODELS
757-S / 762-S

762-S	
Conexión filtro Filter threaded connection Lien filtre	Bayoneta Bayonet Baïonnette
Filtros Filters Filtres	757
Material Material Matière	Silicona Silicone rubber Silicone
Factor de protección nominal (FP) Nominal protection factor (NPF) Facteur protection nominale (FPN)	50
Peso Weight Poids	130 gr
Norm	EN 140



» EQUIPOS DE EVACUACIÓN | EVACUATION EQUIPMENT | MATIÈRE D'ÉVACUATION

761 - 756		
Filtros Filters Filtres	755/756	Mascarilla 756 Mask 756 Masque 756
	760	Mascarilla 761 Mask 761 Masque 761
Material Material Matière	PVC sin forro PVC without lining PVC sans doublure	
Factor de protección nominal (FP) Nominal protection factor (NPF) Facteur protection nominale (FPN)	50	
Norm	EN 140	



Protege al usuario de productos químicos nocivos durante su ruta de escape hacia un ambiente seguro y respirable.
Protects the user from harmful chemicals during their escape route to a safe and breathable environment.
Protège l'utilisateur des produits chimiques nocifs lors de son évacuation vers un environnement sûr et respirant.



» **COMBINACIONES DE FILTRO** | FILTER COMBINATIONS | COMBINAISONS DE FILTRES

725
EN 14387:2004 + A1:2008
EN 143:2000



731-C
731-S

**GAS | GAS FILTERS |
FILTRES GAZ**

- A2 / AX
- A2 B2
- K2
- B2 E2
- A2 B2 E2 K2

**FILTROS PARTÍCULAS
| FILTERS PARTICLES |
FILTRES À PARTICULES**

- P3

**COMBINADO | COMBINED
FILTERS | FILTRES
POLYVALENTS COMBINÉS**

- A2 P3
- B2 E2 P3
- A2 B2 E2 K2 P3
- K2 P3

**ESPECIALES
| SPECIAL FILTERS |
FILTRES SPÉCIAUX**

- A2 B2 E2
K2 Hg P3



755
EN 14387:2004 + A1:2008
EN 143:2000



756
810

**GAS | GAS FILTERS |
FILTRES GAZ**

- A1 / A2 / AX
- B1 E1
- K1
- A1 B1 E1 K1

**FILTROS PARTÍCULAS
| FILTERS PARTICLES |
FILTRES À PARTICULES**

- P3

**COMBINADO | COMBINED
FILTERS | FILTRES
POLYVALENTS COMBINÉS**

- A1 P3 / A1 P2
- A2 P3
- B1 E1 P3
- A1 B1 E1 K1 P3

**FILTROS PARTÍCULAS
| FILTERS PARTICLES |
FILTRES À PARTICULES**

- P3

**ESPECIALES
| SPECIAL FILTERS |
FILTRES SPÉCIAUX**

- A2 B2 E2
K2 Hg P3

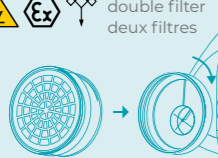
756
EN 14387:2004 + A1:2008
EN 143:2000



756
810

**COMBINADO | COMBINED
FILTERS | FILTRES
POLYVALENTS COMBINÉS**

- A1 P3 / A1 P2
- A2 P3
- B1 E1 P3
- A1 B1 E1 K1 P3

**FILTROS PARTÍCULAS
| FILTERS PARTICLES |
FILTRES À PARTICULES**

- P3

**ESPECIALES
| SPECIAL FILTERS |
FILTRES SPÉCIAUX**

- A2 B2 E2
K2 Hg P3



757-N
EN 14387:2004 + A1:2008
EN 143:2000



732-N
757

**GAS | GAS FILTERS |
FILTRES GAZ**

- A1
- B1 E1
- K1
- A1 B1 E1 K1

**FILTROS PARTÍCULAS
| FILTERS PARTICLES |
FILTRES À PARTICULES**

- P3

**COMBINADO | COMBINED
FILTERS | FILTRES
POLYVALENTS COMBINÉS**



- A1 P3 / A1 P2 /
A2 P3
- B1 E1 P3
- A1 B1 E1 K1 P3

**FILTROS PARTÍCULAS
| FILTERS PARTICLES |
FILTRES À PARTICULES**

- P3

**ESPECIALES
| SPECIAL FILTERS |
FILTRES SPÉCIAUX**

- A2 B2 E2
K2 Hg P3

760
EN 14387:2004 + A1:2008
EN 143:2000



761

**GAS | GAS FILTERS |
FILTRES GAZ**

- A1
- B1 E1
- K1
- A1 B1 E1 K1

**FILTROS PARTÍCULAS
| FILTERS PARTICLES |
FILTRES À PARTICULES**

- P3

**COMBINADO | COMBINED
FILTERS | FILTRES
POLYVALENTS COMBINÉS**

- A1 P3 / A1 P2 /
A2 P3
- B1 E1 P3
- A1 B1 E1 K1 P3

**FILTROS PARTÍCULAS
| FILTERS PARTICLES |
FILTRES À PARTICULES**

- P3

**ESPECIALES
| SPECIAL FILTERS |
FILTRES SPÉCIAUX**

- A2 B2 E2
K2 Hg P3



757
EN 14387:2004 + A1:2008
EN 143:2000



762-S
820

**GAS | GAS FILTERS |
FILTRES GAZ**

- A1
- B1 E1
- K1
- A1 B1 E1 K1

**FILTROS PARTÍCULAS
| FILTERS PARTICLES |
FILTRES À PARTICULES**

- P3

**COMBINADO | COMBINED
FILTERS | FILTRES
POLYVALENTS COMBINÉS**

- A1 P3 / A1 P2 /
A2 P3
- B1 E1 P3
- A1 B1 E1 K1 P3

**FILTROS PARTÍCULAS
| FILTERS PARTICLES |
FILTRES À PARTICULES**

- P3

**ESPECIALES
| SPECIAL FILTERS |
FILTRES SPÉCIAUX**

- A2 B2 E2
K2 Hg P3

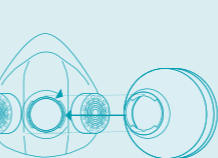



» **CLASES DE FILTROS**
| FILTERS CLASSES |
CLASSES DE FILTRES

GAS GAZ	Capacidad Capacity Capacité	Concentración Concentration Concentration
1	Baja Low Basse	1.000 ppm (0,1%)
2	Medio Medium Moyenne	5.000 ppm (0,5%)
3	Alto High Haute	10.000 ppm (1%)

PARTÍCULAS PARTICLES PARTICULES	Capacidad Capacity Capacité
P1	Baja. Partículas sólidas gruesas y menores. Low. Coarse and smaller solid particles. Basse. Particules solides épaisses et plus petites.
P2	Media. Partículas peligrosas sólidas y líquidas. Medium. Solid and liquid hazardous particles. Moyenne. Particules dangereuses solides et liquides.
P3	Alta. Partículas tóxicas sólidas y líquidas. Partículas radiactivas y microorganismos. High. Solid and liquid toxic particles. Particles radioactive and micro-organism particles. Haute. Particules toxiques solides et liquides. Particules radioactives et micro-organismes.

» **TIPOS DE FILTROS**
| FILTERS CLASSES | TYPE FILTRES

- A** Gases y vapores orgánicos con punto de ebullición > 65 °C.
Organic gases and vapours with boiling point > 65 °C.
Gaz et vapeurs organiques avec point d'ébullition >65 °C.
- B** Gases y vapores inorgánicos (cloro, sulfuro hidrógeno y ácido cianhídrico).
Inorganic gases and vapours (chlorine, hydrogen sulfide and hydrogen cyanide).
Les gaz et vapeurs inorganiques (chlore, sulfure d'hydrogène et l'acide cyanhydrique).
- E** Dióxido de azufre.
Sulfur dioxide.
Dioxyde de soufre.
- K** Amoníaco y sus derivados orgánicos.
Ammonia and organic derivatives of ammonia.
Ammoniac et dérivés organiques.
- P** Filtros contra partículas.
Particle filter.
Filtres à particules.
- Hg P3** Vapores de mercurio, partículas sólidas y líquidas.
Mercury vapours, solid and liquid particles.
Vapeur de mercure, particules solides et liquides.
- AX** Dimetiléter / Isobutano.
Dimethylether / Isobutane.
Diméthyléther / Isobutane.
-  **Protección contra electricidad estática.**
Protection against static electricity.
Protection contre l'électricité statique.
-  **Aparatos y sistemas de protección para uso en atmósferas potenciales explosivas.**
Equipment and protective systems intended for use in potentially explosive atmospheres.
Appareils destinés à être utilisés en Atmosphères EXplosives.



» MASCARILLAS AUTOFILTRANTES CONTRA GASES Y PARTÍCULAS

| FILTERING HALF MASKS AGAINST GASES AND PARTICLES |
DEMI-MASQUES FILTRANTS CONTRE LES GAZ ET LES PARTICULES



*** NUEVO * NEW
* NOUVEAU**

SERIE PCX-700

Material cuerpo facial Facial mask material Matière du corps du visage	Elastómero termoplástico (TPE) Thermoplastic elastomer (TPE) Élastomère thermoplastique (TPE)	
Filtros disponibles Filters available Filtres disponibles	PCX-710	FFAIP3 R D
	PCX-720	FFA2P3 R D
	PCX-730	FFABEKIP3 R D
Factor de protección nominal (FP) Nominal protection factor (NPF) Facteur protection nominale (FPN)	PCX-710	33* VLA
	PCX-720	33* VLA
	PCX-730	33* VLA
Peso Weight Poids	360 gr	
Norm	EN 405	

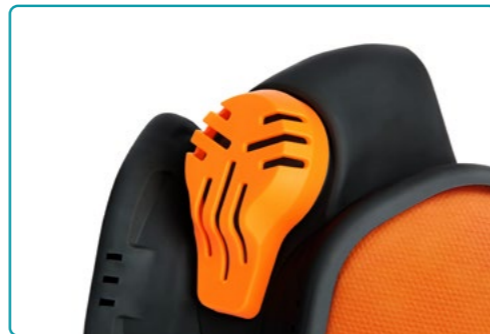

Sistema de fácil ajuste
Easy fitting system
Système de réglage facile



Cierre fácil
Easy lock system
Fermeture facile

Media máscara filtrante con filtros mixtos integrados (gases y partículas). Su diseño permite su uso en combinación con otros equipos de protección como pantallas de soldadura, faciales, gafas, etc.

El cuerpo facial está fabricado en termoplástico hipoalérgico. La posición de los filtros ofrece al usuario un amplio campo visual. Válvula de exhalación de gran diámetro para una exhalación óptima.

Filtering half mask with integrated mixed filters (gases and particles). Its design allows it to be used in combination with other protective equipment such as welding shields, face shields, glasses, etc.

The facial body is made of hypoallergenic thermoplastic. The position of the filters offers the user a wide field of view. Large diameter exhalation valve for optimal exhalation.

Demi-masque filtrant avec filtres mixtes intégrés (gaz et particules). Sa conception lui permet d'être utilisé en combinaison avec d'autres équipements de protection tels que des masques de soudage, des écrans faciaux, des lunettes, etc.

Le corps du visage est en thermoplastique hypoallergénique. La position des filtres offre à l'utilisateur un large champ de vision. Valve d'expiration de grand diamètre pour une exhalation optimale.



NIVELES DE PROTECCIÓN Y SU APLICACIÓN

LEVELS OF PROTECTION AND THEIR APPLICATION
NIVEAUX DE PROTECTION ET LEUR APPLICATION



FFP1 NR

Limpieza a vapor, trabajos de mola, corte y perforación en la construcción, polvo de óxido y metálico resultantes de estos trabajos.

High pressure steam blasting, grinding, cutting and drilling, metal and iron powder resulting from these jobs.

Nettoyage à vapeur, travaux de meulage, découpage et perforation dans la construction, poudre d'oxyde et métallique provenant de ces travaux.

FFP2 NR D

Lijado de capas de pintura y recubrimientos, raspado y lijado de adhesivos, corte y perforación de madera, humos procedentes de la soldadura, gestión de residuos, fumigación de pesticidas (base acuosa), alimentación de animales.

Sanding coats of paint and coatings, scraping and sanding of adhesives, cutting and drilling of wood, smoke particles from welding, waste management, pesticide fumigation, use/cleaning of animal feeding systems.

Ponçage de couches de peinture et de revêtements, raclage et ponçage d'adhésifs, découpage et perforation de bois, fumées provenant de la soudure, gestion de résidus, fumigation de pesticides (base aqueuse), alimentation des animaux, découpage et perforation.

FFP3 NR D

Moladura, corte, perforación de madera, acero inoxidable, pintura, lacas y pintura anticorrosiva. Barnizado con pintura a base de solvente, contacto con bacterias y virus. Retirada de amianto.

Grinding, cutting, drilling of wood, stainless steel, paint, lacquer and anti-corrosion paint. Varnishing with solvent-based paint, contact with bacteria and viruses. Asbestos removal.

Meulage, découpage et perforation de bois, acier inoxydable, peinture, laques et peinture anticorrosive. Vernissage avec peinture à base de solvant, contact avec bactéries et virus. Élimination d'amiante.

Máximo nivel de uso
FFP1: 4 x VLA para partículas
FFP2: 10 x VLA para partículas
FFP3: 20 x VLA para partículas

VLA
Valor límite ambiental.
Valor de referencia para la evaluación y control de los riesgos inherentes a la exposición.

Maximum level of use
FFP1: 4 x TLV
FFP2: 10 x TLV
FFP3: 20 x TLV

TLV
The threshold limit value of a chemical substance is a level to which it is believed a worker can be exposed day after day for a working lifetime without adverse health effects.

Niveau maximal d'utilisation
FFP1: 4 x VME pour particules de poussière
FFP2: 10 x VME pour particules de poussière
FFP3: 20 x VME pour particules de poussière

VME
Valeur Moyenne d'Exposition (pour 8 heures).
Valeur de référence pour évaluation et contrôle de risques inhérents à l'exposition.



Símbolo de la conformidad con la norma europea.
Symbol of conformity to European Standard.
Symbole de conformité avec la norme européenne.

Número de organismo notificado de control.
Notified control body number.
Numéro d'organisme de contrôle notifié

Identificación del fabricante.
Manufacturer Identification.
Identification du fabricant.



1710-V
FFP1

NR D

EN 149:2001 + A1:2009

CE 0161

Tipo de protección.
Class of protection.
Type de protection.

Norma Europea.
European Standard.
Norme européenne.

Referencia del artículo.
Article reference.
Référence de l'article.

NR: Máscara de polvo limitada a un solo uso por turno de trabajo.

R: Máscara re-utilizable para más de un turno de trabajo.

NR: Dust mask limited to a single working shift use only.

R: Re-usable mask, for more than one working shift.

NR: Masque à poussière limitée à une utilisation par session de travail.

R: Réutilisable masque, pour plus d'un quart de travail.

D: Cumple con los requisitos del ensayo de obstrucción con polvo de dolomita.

D: In compliance with dolomite dust clogging test requirements.

D: Conforme aux exigences du test de colmatage de la poussière de dolomie.

» MASCARILLA AUTOFILTRANTE CONTRA PARTÍCULAS

| FILTERING HALF MASK AGAINST PARTICLES | DEMI-MASQUE FILTRANT CONTRE LES PARTICULES



1710



1710-V



1720



1720-V



1730-SV



1730

1710	
Protección Protection Protection	Aerosoles sólidos y líquidos (como neblinas de aceite) no tóxicos. Solid and liquid aerosols (eg. Mist of oil) non-toxic Aérosols solides et liquides non-toxiques
Máximo nivel de uso Maxium level of use Niveau maximum d'utilisation	4x VLA 4 x TLV 4 x VME
Tipos de aplicación Types of uses Types d'application	FFP1 NR
Norm	EN 149:2001+A1:2009

1720	
Protección Protection Protection	Aerosoles sólidos y líquidos (como neblinas de aceite) no tóxicos y de toxicidad media-baja Non-toxic and low-to-avera-ge toxicity solid and liquid aerosols Aérosols solides et liquides non-toxiques. Toxicité faible à moyenne.
Máximo nivel de uso Maxium level of use Niveau maximum d'utilisation	10x VLA 10 x TLV 10 x VME
Tipos de aplicación Types of uses Types d'application	FFP2 NR D
Norm	EN 149:2001+A1:2009

1730	
Protección Protection Protection	Aerosoles sólidos y líquidos (como neblinas de aceite) no tóxicos, de toxicidad media-baja y de alta toxicidad Non-toxic, low-to-average toxicity and high toxicity solid and liquid aerosols Aérosols solides et liquides (p. ex. brouillards d'huile) non-toxiques. Toxicité faible-moyenne-haute
Máximo nivel de uso Maxium level of use Niveau maximum d'utilisation	20x VLA 20 x TLV 20 x VME
Tipos de aplicación Types of uses Types d'application	FFP3 NR D
Norm	EN 149:2001+A1:2009

» MASCARILLA AUTOFILTRANTE CONTRA PARTÍCULAS

| FILTERING MASK AGAINST PARTICLES | DEMI-MASQUE FILTRANT CONTRE LES PARTICULES



* NUEVO * NEW
* NOUVEAU

1820	
Protección Protection Protection	Aerosoles sólidos y líquidos (como neblinas de aceite) no tóxicos y de toxicidad media-baja Non-toxic and low-to-average toxicity solid and liquid aerosols Aérosols solides et liquides non-toxiques. Toxicité faible à moyenne.
Máximo nivel de uso Maxium level of use Niveau maximum d'utilisation	10 x VLA 10 x TLV 10 x VME
Tipos de aplicación Types of uses Types d'application	FFP2 NR D
Norm	EN 149:2001+A1:2009

* NUEVO * NEW
* NOUVEAU

1830	
Protección Protection Protection	Aerosoles sólidos y líquidos (como neblinas de aceite) no tóxicos, de toxicidad media-baja y de alta toxicidad Non-toxic, low-to-average toxicity and high toxicity solid and liquid aerosols Aérosols solides et liquides (p. ex. brouillards d'huile) non-toxiques. Toxicité faible-moyenne-haute
Máximo nivel de uso Maxium level of use Niveau maximum d'utilisation	20x VLA 20 x TLV 20 x VME
Tipos de aplicación Types of uses Types d'application	FFP3 NR D
Norm	EN 149:2001+A1:2009

» MASCARILLA AUTOFILTRANTE

FILTERING HALF MASK | DEMI-MASQUE



Carbón activo
Activated carbon
Charbon actif

1720 -C	
Protección Protection Protection	Aerosoles sólidos y líquidos (como neblinas de aceite, humos procedentes de la soldadura) no tóxicos. Solid and liquid aerosols (eg. mist of oil, welding fumes) non-toxic. Aérosols solides et liquides (comme les brouillards d'huile, les fumées de soudage) non-toxiques.
Máximo nivel de uso Maxium level of use Niveau maximum d'utilisation	10 x VLA 10 x TLV 10 x VME
Tipos de aplicación Types of uses Types d'application	FFP2 NR D
Norm	EN 149:2001+A1:2009

Protección frente al ozono generado en procesos de soldadura y niveles molestos de gases y olores (en concentraciones por debajo del límite de exposición permitido del VLA) originados en procesos industriales.
They provide protection against ozone generated in welding processes and troublesome levels of gases and smells (in concentrations below the permitted TLV exposition limit) caused by industrial processes.
Protection contre l'ozone généré dans des processus de soudure et niveaux agaçants de gaz et odeurs (en concentrations inférieures à la limite d'exposition permise VME) issues des processus industriels.

» MASCARILLA HIGIÉNICA | HYGIENIC MASK | MASQUE HYGIÉNIQUE

708-N	
Tipo Type Type	Mascarilla higiénica no reutilizable Not reusable hygienic mask Masque hygiénique non réutilisable
Protección Protection Protection	Eficacia de la filtración bacteriana (BFE) (%) : 96,16 ± 2,08 Respirabilidad: Presión diferencial (Pa/cm²) : 32,8 ± 1 Bacterial filtration efficiency (BFE) (%) : 96,16 ± 2,08 Breathability: Differential pressure (Pa/cm²) : 32,8 ± 1 Efficacité de filtration bactérienne (BFE) (%) : 96,16 ± 2,08 Respirabilité : Pression différentielle (Pa/cm²) : 32,8 ± 1
Limitaciones de uso Use limitations Limites d'utilisation	Para uso en adultos For use in adults Pour une utilisation chez les adultes
Norm	UNE 0064-1:2020



» FILTRO | FILTER | FILTRE

FILTRO P2	
Protección Protection Protection	Filtro contra partículas, sólidas y líquidas Filter against particles, solid and liquid Filtre contre les particules, solides et liquides
Eficacia de Filtración Filtration efficiency Efficacité de filtration	P2
Combina con filtros Climax: Combine with Climax filters: Se combine avec les filtres Climax:	755 A1, 755 ABEK1
Norm	EN 14387:2004+A1:2008



Reutilizable
Reusable
Réutilisable

» POSIBILIDAD DE PERSONALIZAR

POSSIBILITY TO CUSTOMIZE | POSSIBILITÉ DE PERSONNALISER*

- 1 Marcado**
Marking · Marquage
- 2 Color**
Color · Couleur
- 3 Empaquetado**
Packaging · Conditionnement



Aquí su logo
Your logo goes here
Emplacement de votre logo



Con válvula: 12 ud/caja / Sin válvula: 20 ud/caja
With valve: 12 units/box / Without valve: 20 units/box
Avec valve: 12 unités/boîte / Sans valve: 20 unités/boîte

* Consultar condiciones. Opción no disponible para las mascarillas autofiltrantes de carbón activo.
* Consult conditions. Option not available for active carbon auto-filter masks. * Consultez conditions. Pas de disponibilité pour les masques de filtre à charbon actif.

» TABLA DE CÓDIGOS DE FILTROS ACOPLABLES

TABLE WITH CODES OF FILTERS THAT CAN BE FITTED | TABLEAU DES CODES DE FILTRES ADAPTABLES

A	Acetato de n-amilo / Amyl acetate	A-P3	Bromuro de hidrógeno / Hydrogen bromide	E-P3	Dietanolamina / Diethanolamine	AP3
	Acetato de n-butilo / Butyl acetate	A	n-Butano / Butane	AX	2-Dietilaminoetanol / 2-Diethylaminoethanol	A
	Acetato de etilo / Ethyl acetate	A	n-Butilamina / n-Butylamine	K	Dietilcetona / Diethyl ketone	A
	Acetato de n-propilo / n-Propyl acetate	A	C Camfor / Camphor, synthetic	A-P3	Difenilcetona / Benzophenone	AP3
	Acetato de vinilo / Vinyl acetate	A	Caprolactama, vapor y polvo / Caprolactam fume	A-P3	Difenilo / Biphenyl	AP3
	Acetileno / Acetylene	Air line	Carbonato cálcico / Calcium carbonate	P3	Dimetilamina / Dimethylamine	K
	Acetona / Acetone	AX	Carbonato de sodio / Sodium bicarbonate	P3	Dimetilbenceno / Xylene	A
	Ácido acético / Acetic acid	A-P3	Celulosa / Cellulose	P3	Dinitrobenceno / Dinitrobenzene	AP3
	Ácido acrílico / Acrylic acid	A	Cemento Portland / Cement	P3	Dióxido de azufre / Sulfur dioxide	E
	Ácido benzoico / Benzoic acid	P3	Cianamida de calcio / Calcium cyanamide	P3	Disolvente Stoddard / Stoddard solvent	A
	Ácido bromhídrico / Hydrobromic acid	BP3	Cianuro cálcico / Calcium cyanide	P3	Disulfuro de carbono / Carbon bisulphide	A
	Ácido cianhídrico / Hydrogen cyanide	BP3	Cianuro potásico / Potassium cyanide	P3	E Estaño (como Sn) / Stannum	AP3
	Ácido clorhídrico / Hydrogen chloride	BP3	Cianuro sódico / Sodium cyanide	P3	Estireno (monómero) / Styrene	A
	Ácido fluorhídrico / Hydrogen fluoride	BP3	Ciclohexano / Cyclohexane	A	Estricnina / Strychnine	P3
	Ácido nítrico / Nitric acid	BP3	Ciclohexanol / Cyclohexanol	A	Etanolamina / Ethanolamine	A
	Ácido oxálico / Oxalic acid	AP3	Ciclohexanona / Cyclohexanone	A	Etilamina / Ethylamine	K
	Ácido pícrico / Picric acid	P3	Ciclohexeno / Cyclohexene	A	Etilbenceno / Ethylbenzene	A
	Ácido sulfúrico / Sulfuric acid	EP3	Ciclohexilamina / Cyclohexylamine	A	Etilenglicol / Ethylene glycol	AP3
	Aguarrás / White spirit	A	Ciclonita / Cyclonite (RDX)	P3	F Feniléter-bifenilo / Phenyl ether-biphenyl eutectic	AP3
	Alcohol alílico / Allyl alcohol	A	Cloro / Chlorine	B	Fenol / Phenol	AP3
	Alcohol de n-amilo / N-amy alcohol	A	Clorobenceno / Chlorobenzene	A	Fibra de vidrio, polvo / Fiberglass dust	P3
	Alcohol de bencilo / Benzyl Alcohol	A	o-Clorobencilideno malonitrilo / o-Chlorobenzylidene malononitrile (CS)	A-P3	Fluoruro de hidrógeno / Hydrogen fluoride	E
	Alcohol isopropílico / Isopropyl alcohol	A	2-Cloroetanol / 2-Chloroethanol	A	Fuel / Fuel oil	AP3
	Alcoholes minerales / Stoddard solvent	A	Cloroformo / Chloroform	AX	G Gasóleo / Diesel fuel	AP3
	Alcohol n-propílico / n-propyl alcohol	AP3	o-Clorotolueno / o-Chlorotoluene	A	Gasolina / Gasoline	A
	Algodón / Cotton dust	P3	Cloruro amónico, humos / Ammonium chloride fume	K	Gel de sílice / Silica gel	P3
	Almidón / Amylum	P3	Cloruro de aluminio / Aluminium chloride	B-P3	Glicerina, niebla / Glycerol	P3
	Alquitrán de hulla / Coal-tar pitch	AP3	Cloruro de bencilo / Benzyl chloride	A-P3	Glutaraldehído / Glutaraldehyde	AP3
	Aluminio, metal / Aluminium metal	P3	Cloruro de fenacilo / 2-Chloroacetophenone	A-P3	H N-Heptano / n-Heptane	A
	Aluminio, óxidos / Aluminium oxide	P3	Cloruro de hidrógeno / Hydrochloric acid	E	Hexacloroetano / Hexachloroethane	AP3
	Aluminio, sales solubles / Aluminium, soluble salts	P3	Cloruro de p-toluensulfonilo / p-Toluenesulfonyl chloride	E-P3	Hexano (otros isómeros) / Hexane	A
	2 Aminoetanol / 2-Aminoethanol	A	Cloruro de tionilo / Thionyl chloride	E-P3	Hexona / Methyl isobutyl ketone	A
	Amoniaco / Ammonia	K	Cobalto (como Co) / Cobalt	P3	Hidrocarburos aromáticos policíclicos / PAHs	AP3
	Anilina / Aniline	A	Cobre (humos, polvo y nieblas) / Cobalt metal (dust and fume & mixt)	P3	Hipoclorito sódico / Sodium hypochlorite	EP3
	o-, p-Anisidina / Anisidine, o-, p-isomers	A-P3	Cresoles / Cresol	AP3	I Isobutanol / Isobutanol	A
	Antimonio y compuestos (como Sb) / Antimony and compounds (as Sb)	P3	Criolita / Cryolite	P3	Isopropanol / Isopropanol	A
	Arsénico y compuestos inorgánicos (excepto Arsina) (como As) / Arsenic & compounds (except Arsine)	P3	Cromato cálcico / Calcium chromate	P3	Isopropilamina / Isopropylamine	K
	Asfalto de petróleo, humos / Asphalt (petroleum fumes)	AP3	Cromato de cinc / Zinc chromate	P3	Isopropiléter / Diisopropyl ether	A
	Asbestos / Asbestos	P3	Cromato de cromo (III) / Chromium chromate	P3	L Legionella / legionella pneumophila	P3
B	1,3- Butadieno / 1,3-Butadiene	AX	Cromato de estroncio / Strontium chromate	P3	Lejía doméstica / Sodium hypochlorite	EP3
	2-Butanona / 2-Butanone	A	Cromato de plomo / Lead chromate	P3	M Magnesita / Magnesium carbonate	P3
	Bario y compuestos solubles (como Ba) / Barium compounds	P3	Cromo (humo y polvos metálicos) / Chromium metal & Chromium Dust	P3	Mármol / Calcium carbonate	P3
	Benceno / Benzene	A	Cuarzo (sílice) / Silicon dioxide	P3	Mercurio, vapor / Mercury	Hg-P3
	Benzaldehído / Benzaldehyde	A	D Dibutilamina / Dibutylamine	A	Metilamina / Methylamine	K
	Benzofenona / Benzophenone	A-P3	Diciclopentadieno / Dicyclopentadiene	AP3	Metilciclohexano / Methylcyclohexane	A
	p-Benzoquinona / p-Benzoquinone	A-P3	o-Diclorobenceno / 1,2-dichlorobenzene	AP3	-Metilestireno / Alpha-methylstyrene	AP3
	Bifenilo / Biphenyl	A-P3	P-Diclorobenceno / 1,4-dichlorobenzene	AP3	Metiletilcetona / Methyl ethyl ketone	A
	Bisulfito de sodio / Sodium bisulfite	E-P3	1,2 Dicloropropano / 1,2-dichloropropane	A	N Nafta / Petroleum ether	A
	Bromato de potasio / Potassium bromate	P3	Dicloruro de propileno / 1,2-dichloropropane	A	Naftaleno / Naphthalene	AP3
	Bromo / Bromine	B-P3	O Óxido de aluminio / Aluminum oxide	P3	Negro de humo / Carbon black	P3
	Bromoformo / Bromoform	A	Óxido de boro / Boric oxide	P3	Niquel / Nickel	P3
	Bromometano / Bromomethane	AX	Óxido de cinc, polvo / Zinc oxide, dust	P3		

	Óxido de hierro / Iron (III) oxide	P3	Sulfumán / Hydrochloric acid	E	Tricloroetileno / Trichloroethylene	A
	Ozono / Ozone	A	Virus del síndrome respiratorio / SARS	P3	Tricloronaftaleno / Trichloronaphthalene	AP3
P	PCBs	AP3	Silicato cálcico / Calcium silicate	P3	Trietilamina / Triethylamine	A
	Pentacloruro de fósforo / Phosphorus pentachloride	EP3	Silíce cristalina / Silica white	P3	Trimetilamina / Trimethylamine	K
	1-Pentanol / 1-Pentanol	A	Silicio / Silicon	P3	2,4,6-Trinitrotolueno (TNT) / 2,4,6-Trinitrotoluene	AP3
	Piridina / Pyridine	A	Sosa cáustica / Sodium hydroxide	P3	Tungsteno, humos metálicos / Tungsten (metal, oxide dusts)	P3
	Plata, metal / Silver, metal	P3	Sulfato de bario / Barium sulfate	P3	U Urea / Urea	KP3
	Plomo, metal / Lead, metal	P3	Sulfato de calcio / Calcium sulfate	P3	V Vidrio, fibra / Fiber glass	P3
	Polietilenglicol, PEG / Polyethylene Glycol	P3	T Talco / Talc	P3	Vinil benceno / Styrene	A
	Polipropilenglicol, PPG / Propylenglycol	P3	Tierras diatomeas / Diatomaceous earth	P3	X m-Xileno / m-Xylene	A
Q	Queroseno / Kerosene	A	Tolueno / Toluene	A	o-Xileno / o-Xylene	A
	Quinona / 1,4-Benzoquinone	AP3	Trementina / Oil of turpentine	AP3	p-Xileno / p-Xylene	A
R	Rodio metal / Rhodium powder	P3	Tribromometano / Bromoform	A	Y Yeso / Calcium sulfate	P3
S	Sacarosa / Sucrose	P3	1,2,4-Triclorobenceno / 1,2,4-Trichlorobenzene	A		





PROTECCIÓN CONTRA CAÍDAS
FALL PROTECTION
PROTECTION ANTI CHUTES



» **FORMACIÓN** | TRAINING | FORMATION



» **REVISIÓN** | REVISION | RÉVISION



CURSOS DE FORMACIÓN PARA EMPRESAS, PROFESIONALES O PARTICULARES DE TRABAJOS EN ALTURA O ESPACIOS CONFINADOS:

- Amplia cobertura.
- Flexibilidad de días y horarios.
- Instalaciones propias: Circuito práctico.
- Equipo técnico altamente cualificado.
- Utilización de equipos personalizados.
- Apropriados para cada ámbito laboral.
- Demostración del proceso de fabricación y ensayos de seguridad de los EPIS.

ASESORAMIENTO TÉCNICO A EMPRESAS

- Visita a planta y análisis de situaciones de riesgo.
- Realización informe y resultado nivel de riesgo.
- Propuesta medidas correctivas.

TRAINING COURSES FOR COMPANIES, PROFESSIONALS OR PRIVATE INDIVIDUALS FOR WORKING AT A HEIGHT OR IN CONFINED SPACES:

- Wide coverage.
- Flexibility regarding days and times.
- Own installations: Practice circuit.
- Highly qualified technical team.
- Use of personalised equipment.
- Appropriate for each work environment.
- Demonstration of manufacturing and tests.

TECHNICAL ADVICE FOR COMPANIES

- Visit of plant and analysis of hazard situations.
- Make a report with hazard level results.
- Proposals for corrective measures.

POUR DES ENTREPRISES, DES PARTICULIERS OU DES PROFESSIONNELS DES TRAVAUX EN HAUTEUR OU DES ESPACES CONFINÉS

- Large couverture.
- Flexibilité journalière et horaire.
- Installations propres: Circuit pratique.
- Équipe technique très qualifiée.
- Utilisation d'équipements personnalisés.
- Adaptés à tout domaine de travail.
- Démonstration du processus de fabrication et essais de sécurités des EPIS.

ASSISTANCE TECHNIQUE AUX ENTREPRISES

- Visite des installations et analyse des situations de risque.
- Élaboration du rapport technique et résultats du niveau de risque.
- Proposition de mesures correctives.

CURSOS PARA LA REVISIÓN PERIÓDICA DE LOS EPI CONTRA CAÍDAS EN ALTURA

Segun normativa EN 365 se establece la obligatoriedad de revisión de los EPI utilizados durante los trabajos en altura.

Siendo así, Productos Climax ofrece cursos de capacitación para realizar las revisiones periódicas de los EPI, identificar los daños y/o los desperfectos que pueden afectar a la seguridad y/o funcionalidad de los EPI, elaborar informes escritos de las revisiones y determinar las acciones específicas a realizar.

¿A quién va dirigido?

A las personas, designadas por el empresario, cuya responsabilidad sea realizar la revisión de los EPI contra caídas de altura fabricados por Productos Climax.

Para más información consultar el Departamento Técnico: info@productosclimax.com

COURSES ON PERIODIC REVISION OF PPE AGAINST FALLS FROM A HEIGHT

According to regulation EN 365, it is established the obligation to review the PPE used while working at height.

The purpose of the course is to qualify users to perform periodic revisions on PPE, to identify the damage and/or deterioration which may affect the safety and/or functionality of PPE, to draft written reports on the revisions and to determine the specific actions to be followed.

Who is it aimed at?

At those people designated by the employer who will be responsible for performing revisions on PPE (manufactured by Productos Climax) against falls from a height

For further information, contact our technical dptm: info@productosclimax.com.

COURS DE RÉVISION PÉRIODIQUE DES EPI CONTRE LES CHUTES EN HAUTEUR

D' accord à la réglementation EN 365, il est obligé de faire une révision des EPI utilisés pendant les travaux en hauteur.

La finalité du cours est de donner les moyens à l'utilisateur pour effectuer les révisions périodiques des EPI, d'identifier les dégâts et/ou dommages pouvant affecter la sécurité et/ou la fonctionnalité des EPI, d'élaborer des rapports écrits des révisions et de déterminer les actions spécifiques à réaliser.

A qui s'adresse-t-il?

Aux personnes désignées par le chef d'entreprise, dont la responsabilité consiste en la révision périodique des EPI contre les chutes en hauteur fabriqués par Productos Climax.

Pour plus d'information, contactez notre bureau technique: info@productosclimax.com



» ARNESES ANTICAÍDAS FULL BODY HARNESSES | HARNAIS ANTI-CHUTES

* NUEVO * NEW
* NOUVEAU

Atlas Rescate

Aplicación
Application

Anticaídas (EN 361) / Posicionamiento (EN 358) /
Suspensión (EN 813) / Rescate (EN 1497)
Fall arrest (EN 361) / Positioning (EN 358) /
Suspension (EN 813) / Rescue (EN 1497)
Antichute (EN 361) / Positionnement (EN 358) /
Suspension (EN 813) / Sauvetages (EN 1497)

2 puntos de anclaje anticaídas (A): dorsal y frontal
2 fall arrest anchoring points (A): dorsal and chest
2 points d'ancrage anti-chutes (A): dorsal et frontal

Anclaje ventral de suspensión
Ventral suspension anchor point
Ventral de suspension points d'ancrage

2 hebillas laterales abatibles de posicionamiento
2 lateral folding positioning buckles
2 boucles laterales de positionnement rabattables

Descripción
Description

Hebillas de rápida actuación en banda de cintura,
perneras y en cierre pectoral
Quick-fit buckles on waistband, leg supports and chest
Boucles rapides au niveau de la taille, des cuissardes et
poitrine

Acolchamiento en banda de cintura, perneras y espalda
Padding waist, legs and back
Bande ceinture, épaule et cuissardes matelassées.

Espuma de confort
Comfort foam
Mousse de confort

3 aros portamateriales
3 material holding rings
3 anneaux porte-outils



Punto de Rescate EN 1497 de extracción vertical
Rescue Point EN 1497 with vertical extraction
Rescue Point EN 1497 avec extraction verticale





» ARNESES ANTICAÍDAS FULL BODY HARNESSES | HARNAIS ANTI-CHUTES

140 kg



Atlas Plus

Aplicación Application Application	Anticaídas (EN 361) / Posicionamiento (EN 358) / Suspensión (EN 813) Fall arrest (EN 361) / Positioning (EN 358) / Suspension (EN 813) Antichute (EN 361) / Positionnement (EN 358) / Suspension (EN 813)
	2 puntos de anclaje anticaídas (A): dorsal y frontal 2 fall arrest anchoring points (A): dorsal and chest 2 points d'ancrage anti-chutes (A): dorsal et frontal
	Anclaje ventral de suspensión Ventral suspension anchor point Ventral de suspension points d'ancrage
	2 hebillas laterales abatibles de posicionamiento 2 lateral folding positioning buckles 2 boucles laterales de positionnement rabattables
Descripción Description Description	Hebillas de rápida actuación en banda de cintura, perneras y en cierre pectoral Quick-fit buckles on waistband, leg supports and chest Boucles rapides au niveau de la taille, des cuissardes et poitrine
	Acolchamiento en banda de cintura, perneras y espalda Padding waist, legs and back Bande ceinture, épaule et cuissardes matelassées.
	Espuma de confort Comfort foam Mousse de confort
	3 aros portamateriales 3 material holding rings 3 anneaux porte-outils

140 kg



Atlas

Aplicación Application Application	Anticaídas (EN 361) / Posicionamiento (EN 358) / Suspensión (EN 813) Fall arrest (EN 361) / Positioning (EN 358) / Suspension (EN 813) Antichute (EN 361) / Positionnement (EN 358) / Suspension (EN 813)
	2 puntos de anclaje anticaídas (A): dorsal y frontal 2 fall arrest anchoring points (A): dorsal and chest 2 points d'ancrage anti-chutes (A): dorsal et frontal
	Anclaje ventral de suspensión Ventral suspension anchor point Ventral de suspension points d'ancrage
	2 hebillas laterales abatibles de posicionamiento 2 lateral folding positioning buckles 2 boucles laterales de positionnement rabattables
Descripción Description Description	Hebillas de rápida actuación en banda de cintura, perneras y en cierre pectoral Quick-fit buckles on waistband, leg supports and chest Boucles rapides au niveau de la taille, des cuissardes et poitrine
	Acolchamiento en banda de cintura y perneras Padding waist and legs Bande ceinture et cuissardes matelassées.
	3 aros portamateriales 3 material holding rings 3 anneaux porte-outils

140 kg



Atlas Dieléctrico

Aplicación Application Application	Anticaídas (EN 361) / Posicionamiento (EN 358) / Suspensión (EN 813) Fall arrest (EN 361) / Positioning (EN 358) / Suspension (EN 813) Antichute (EN 361) / Positionnement (EN 358) / Suspension (EN 813)
	2 puntos de anclaje anticaídas (A): dorsal y frontal 2 fall arrest anchoring points (A): dorsal and chest 2 points d'ancrage anti-chutes (A): dorsal et frontal
	Anclaje ventral de suspensión Ventral suspension anchor point Ventral de suspension points d'ancrage
	2 hebillas laterales abatibles de posicionamiento 2 lateral folding positioning buckles 2 boucles laterales de positionnement rabattables
Descripción Description Description	Hebillas en resina de PVC. Rigidez dieléctrica 9 (kV) Buckles in PVC resin. Dielectric strength 9 (kV) Boucles en résine PVC. Rigidité diélectrique 9 (kV)
	Acolchamiento en banda de cintura y perneras Padding waist and legs Bande ceinture et cuissardes matelassées.
	3 aros portamateriales 3 material holding rings 3 anneaux porte-outils



Atlas Tree Integral Arboricultura

Aplicación Application Application	Anticaídas (EN 361) / Posicionamiento (EN 358) / Suspensión (EN 813) Fall arrest (EN 361) / Positioning (EN 358) / Suspension (EN 813) Antichute (EN 361) / Positionnement (EN 358) / Suspension (EN 813)
	2 puntos de anclaje anticaídas (A): dorsal y frontal 2 fall arrest anchoring points (A): dorsal and chest 2 points d'ancrage anti-chutes (A): dorsal et frontal
	2 puntos de anclaje de suspensión ventral 2 mobile ventral anchoring points 2 points d'ancrage ventral mobile
	Hebillas laterales abatibles de posicionamiento Lateral folding positioning buckles Boucles laterales de positionnement rabattables
Descripción Description Description	Hebillas de rápida actuación en banda de cintura, perneras y en cierre pectoral Quick-fit buckles on waistband, leg supports and chest Boucles rapides au niveau de la taille, des cuissardes et poitrine
	Acolchamiento en banda de cintura, perneras y espalda Padding waist, legs and back Bande ceinture, épaule et cuissardes matelassées.
	Espuma de confort Comfort foam Mousse de confort
	3 aros portamateriales 3 material holding rings 3 anneaux porte-outils

140 kg



Giratorio
Rotary
Rotatif

Móvil
Mobile
Mobile



140 kg



Rota Confort Plus

Aplicación Application Application	Anticaídas (EN 361) / Posicionamiento (EN 358) Fall arrest (EN 361) / Positioning (EN 358) Antichute (EN 361) / Positionnement (EN 358)
Descripción Description Description	2 puntos de anclaje anticaídas (A): dorsal y frontal 2 fall arrest anchoring points (A): dorsal and chest 2 points d'ancrage anti-chutes (A): dorsal et frontal
	2 hebillas laterales abatibles de posicionamiento 2 lateral folding positioning buckles 2 boucles laterales de positionnement rabattables
	Hebillas de rápida actuación en banda de cintura y perneras Quick-fit buckles on waistband and leg supports Boucles rapides au niveau de la taille et des cuissardes
	Acolchamiento en banda de cintura, perneras y espalda Padding waist, legs and back Bande ceinture, épaule et cuissardes matelassées.
	Espuma de confort Comfort foam Mousse de confort
	2 aros portamateriales 2 material holding rings 2 anneaux porte-outils

140 kg



Rota Confort

Aplicación Application Application	Anticaídas (EN 361) / Posicionamiento (EN 358) Fall arrest (EN 361) / Positioning (EN 358) Antichute (EN 361) / Positionnement (EN 358)
Descripción Description Description	2 puntos de anclaje anticaídas (A): dorsal y frontal 2 fall arrest anchoring points (A): dorsal and chest 2 points d'ancrage anti-chutes (A): dorsal et frontal
	2 hebillas laterales abatibles de posicionamiento 2 lateral folding positioning buckles 2 boucles laterales de positionnement rabattables
	Hebillas de rápida actuación en banda de cintura y perneras Quick-fit buckles on waistband and leg supports Boucles rapides au niveau de la taille et des cuissardes
	Acolchamiento en banda de cintura y perneras Padding waist and legs Bande ceinture et cuissardes matelassées.
	Espuma de confort Comfort foam Mousse de confort
	2 aros portamateriales 2 material holding rings 2 anneaux porte-outils

Rota Confort Dieléctrico

Aplicación Application Application	Anticaídas (EN 361) / Posicionamiento (EN 358) Fall arrest (EN 361) / Positioning (EN 358) Antichute (EN 361) / Positionnement (EN 358)
Descripción Description Description	2 puntos de anclaje anticaídas (A): dorsal y frontal 2 fall arrest anchoring points (A): dorsal and chest 2 points d'ancrage anti-chutes (A): dorsal et frontal
	2 hebillas laterales abatibles de posicionamiento 2 lateral folding positioning buckles 2 boucles laterales de positionnement rabattables
	Hebillas en resina de PVC. Rigidez dieléctrica 9 (kV) Buckles in PVC resin. Dielectric strength 9 (kV) Boucles en résine PVC. Rigidité diélectrique 9 (kV)
	Acolchamiento en banda de cintura y perneras Padding waist and legs Bande ceinture et cuissardes matelassées.
	2 aros portamateriales 2 material holding rings 2 anneaux porte-outils



140 kg



Veleta Plus

Aplicación Application Application	Anticaídas (EN 361) / Posicionamiento (EN 358) Fall arrest (EN 361) / Positioning (EN 358) Antichute (EN 361) / Positionnement (EN 358)
Descripción Description Description	2 puntos de anclaje anticaídas (A): dorsal y frontal 2 fall arrest anchoring points (A): dorsal and chest 2 points d'ancrage anti-chutes (A): dorsal et frontal
	2 Hebillas laterales de posicionamiento abatibles 2 Foldable positioning rings 2 Boucles latérales rabattables
	Acolchamiento en banda de cintura, perneras y espalda Padding waist, legs and back Bande ceinture, épaule et cuissardes matelassées.
	Espuma de confort Comfort foam Mousse de confort
	2 aros portamateriales 2 material holding rings 2 anneaux porte-outils





Veleta Plus Dieléctrico

Aplicación Application Application	Anticaídas (EN 361) / Posicionamiento (EN 358) Fall arrest (EN 361) / Positioning (EN 358) Antichute (EN 361) / Positionnement (EN 358)
Descripción Description Description	2 puntos de anclaje anticaídas (A): dorsal y frontal 2 fall arrest anchoring points (A): dorsal and chest 2 points d'ancrage anti-chutes (A): dorsal et frontal
	2 Hebillas laterales de posicionamiento abatibles 2 Foldable positioning rings 2 Boucles latérales rabattables
	Hebillas en resina de PVC. Rigidez dieléctrica 9 (kV) Buckles in PVC resin. Dielectric strength 9 (kV) Boucles en résine PVC. Rigidité diélectrique 9 (kV)
	Acolchamiento en banda de cintura, perneras y espalda Padding waist, legs and back Bande ceinture, épaule et cuissardes matelassées.
	Espuma de confort Comfort foam Mousse de confort
	2 aros portamateriales 2 material holding rings 2 anneaux porte-outils



Maxipro Plus

Aplicación Application Application	Anticaídas (EN 361) / Posicionamiento (EN 358) Fall arrest (EN 361) / Positioning (EN 358) Antichute (EN 361) / Positionnement (EN 358)
Descripción Description Description	2 puntos de anclaje anticaídas (A): dorsal y frontal 2 fall arrest anchoring points (A): dorsal and chest 2 points d'ancrage anti-chutes (A): dorsal et frontal
	2 hebillas laterales de posicionamiento 2 lateral positioning buckles 2 boucles latérales de positionnement
	Acolchamiento en banda de cintura, perneras y espalda Padding waist, legs and back Bande ceinture, épaule et cuissardes matelassées.
	Espuma de confort Comfort foam Mousse de confort



Veleta

Aplicación Application Application	Anticaídas (EN 361) Fall arrest (EN 361) Antichute (EN 361)
Descripción Description Description	2 puntos de anclaje anticaídas (A): dorsal y frontal 2 fall arrest anchoring points (A): dorsal and chest 2 points d'ancrage anti-chutes (A): dorsal et frontal
	Acolchamiento en banda de perneras y espalda Padding waist and legs Bande épaule et cuissardes matelassées.
	2 aros portamateriales 2 material holding rings 2 anneaux porte-outils

Maxipro

Aplicación Application Application	Anticaídas (EN 361) / Posicionamiento (EN 358) Fall arrest (EN 361) / Positioning (EN 358) Antichute (EN 361) / Positionnement (EN 358)
Descripción Description Description	2 puntos de anclaje anticaídas (A): dorsal y frontal 2 fall arrest anchoring points (A): dorsal and chest 2 points d'ancrage anti-chutes (A): dorsal et frontal
	2 hebillas laterales de posicionamiento 2 lateral positioning buckles 2 boucles latérales de positionnement
	Acolchamiento en banda de cintura Padding waist Bande ceinture matelassée.





Maxipro Dieléctrico

Aplicación Application Application	Anticaídas (EN 361) / Posicionamiento (EN 358) Fall arrest (EN 361) / Positioning (EN 358) Antichute (EN 361) / Positionnement (EN 358)
Descripción Description Description	2 puntos de anclaje anticaídas (A): dorsal y frontal 2 fall arrest anchoring points (A): dorsal and chest 2 points d'ancrage anti-chutes (A): dorsal et frontal
	2 hebillas laterales de posicionamiento 2 lateral positioning buckles 2 boucles laterales de positionnement
	Hebillas en resina de PVC. Rigidez dieléctrica 9 (kV) Buckles in PVC resin. Dielectric strength 9 (kV) Boucles en résine PVC. Rigidité diélectrique 9 (kV)
	Acolchamiento en banda de cintura Padding waist Bande ceinture matelassée.



21-C Ignífugo

Aplicación Application Application	Anticaídas (EN 361) Fall arrest (EN 361) Antichute (EN 361)
Descripción Description Description	2 puntos de anclaje anticaídas (A): dorsal y frontal 2 fall arrest anchoring points (A): dorsal and chest 2 points d'ancrage anti-chutes (A): dorsal et frontal
	Hebillas automáticas en perneras Automatic buckles on legs Boucles automatiques sur les cuisses
	Cinta tratada con retardante Pyrovatex® Straps treated with Pyrovatex Sangles traitées avec Pyrovatex
	2 aros portamateriales 2 material holding rings 2 anneaux porte-outils



21-C Atex Plus

Aplicación Application Application	Anticaídas (EN 361) Fall arrest (EN 361) Antichute (EN 361)
Descripción Description Description	2 puntos de anclaje anticaídas (A): dorsal y frontal 2 fall arrest anchoring points (A): dorsal and chest 2 points d'ancrage anti-chutes (A): dorsal et frontal
	Hebillas automáticas en perneras Automatic buckles on legs Boucles automatiques sur les cuisses
	Espaldera reforzada y transpirable Reinforced and breathable back support Support dorsal renforcé et transpirable
	Perneras acolchadas Padded leg traps Cuissardes matelassées
	2 aros portamateriales 2 material holding rings 2 anneaux porte-outils



21-C Atex

Aplicación Application Application	Anticaídas (EN 361) Fall arrest (EN 361) Antichute (EN 361)
Descripción Description Description	2 puntos de anclaje anticaídas (A): dorsal y frontal 2 fall arrest anchoring points (A): dorsal and chest 2 points d'ancrage anti-chutes (A): dorsal et frontal
	Hebillas automáticas en perneras Automatic buckles on legs Boucles automatiques sur les cuisses
	2 aros portamateriales 2 material holding rings 2 anneaux porte-outils





48-C

Aplicación Anticaídas (EN 361) / Posicionamiento (EN 358)
| Application | Fall arrest (EN 361) / Positioning (EN 358)
Application | Antichute (EN 361) / Positionnement (EN 358)

2 puntos de anclaje anticaídas (A): dorsal y frontal
2 fall arrest anchoring points (A): dorsal and chest
2 points d'ancrage anti-chutes (A): dorsal et frontal

Descripción 2 hebillas laterales de posicionamiento
| Description | 2 lateral positioning buckles
Description | 2 boucles laterales de positionnement

Hebillas regulables en perneras y zona pectoral
Adjustable buckles in leg support and chest area
Boucles réglables aux cuissardes et zone pectorale



Trópico

Aplicación Anticaídas (EN 361 ANSI / ASSE Z359.1-2007)
| Application | Fall arrest (EN 361 ANSI / ASSE Z359.1-2007)
Application | Antichute (EN 361 ANSI / ASSE Z359.1-2007)

2 puntos de anclaje anticaídas (A): dorsal y frontal
2 fall arrest anchoring points (A): dorsal and chest
2 points d'ancrage anti-chutes (A): dorsal et frontal

Descripción Hebillas regulables en perneras y zona lumbar
| Description | Adjustable buckles on leg support and lumbar area.
Description | Boucles rapides aux cuissardes et zone lombaire.

Adjustable buckles on leg support and lumbar area.
Boucles rapides aux cuissardes et zone lombaire.



140 kg



140 kg



27-C

Aplicación Application Application	Anticaídas (EN 361) Fall arrest (EN 361) Antichute (EN 361)
Descripción Description Description	2 puntos de anclaje anticaídas (A): dorsal y frontal 2 fall arrest anchoring points (A): dorsal and chest 2 points d'ancrage anti-chutes (A): dorsal et frontal Hebillas regulables en perneras y zona pectoral Adjustable buckles in leg support and chest area Boucles réglables aux cuissardes et zone pectorale

140 kg



29-C

Aplicación Application Application	Anticaídas (EN 361) Fall arrest (EN 361) Antichute (EN 361)
Descripción Description Description	2 puntos de anclaje anticaídas (A): dorsal y frontal 2 fall arrest anchoring points (A): dorsal and chest 2 points d'ancrage anti-chutes (A): dorsal et frontal Hebillas regulables en perneras y zona pectoral Adjustable buckles in leg support and chest area Boucles réglables aux cuissardes et zone pectorale

30-C

Aplicación Application Application	Anticaídas (EN 361) Fall arrest (EN 361) Antichute (EN 361)
Descripción Description Description	2 puntos de anclaje anticaídas (A): dorsal y frontal 2 fall arrest anchoring points (A): dorsal and chest 2 points d'ancrage anti-chutes (A): dorsal et frontal Hebillas regulables en perneras Adjustable buckles in leg support Boucles réglables aux cuissardes



10 Basic Plus

Aplicación Application Application	Anticaídas (EN 361) Fall arrest (EN 361) Antichute (EN 361)
Descripción Description Description	2 puntos de anclaje anticaídas (A): dorsal y frontal 2 fall arrest anchoring points (A): dorsal and chest 2 points d'ancrage anti-chutes (A): dorsal et frontal Hebillas regulables en perneras Adjustable buckles on leg support Boucles rapides aux cuissardes





10 Basic

Aplicación Application Application	Anticaídas (EN 361) Fall arrest (EN 361) Antichute (EN 361)
Descripción Description Description	1 punto de anclaje anticaídas dorsal 1 fall arrest anchoring point 1 point d'ancrage anti-chutes dorsal Hebillas regulables en perneras Adjustable buckles in leg support Boucles réglables aux cuissardes



26-C

Aplicación Application Application	Anticaídas (EN 361 ANSI / ASSE Z359.1-2007) Fall arrest (EN 361 ANSI / ASSE Z359.1-2007) Antichute (EN 361 ANSI / ASSE Z359.1-2007)
Descripción Description Description	1 punto de anclaje anticaídas dorsal 1 fall arrest anchoring point 1 point d'ancrage anti-chutes dorsal Hebillas regulables en perneras y zona pectoral Adjustable buckles in leg support and chest area Boucles réglables aux cuissardes et zone pectorale

140 kg

28-N

Aplicación Application Application	Anticaídas (EN 361) Fall arrest (EN 361) Antichute (EN 361)
Descripción Description Description	1 punto de anclaje anticaídas dorsal 1 fall arrest anchoring point 1 point d'ancrage anti-chutes dorsal Hebillas regulables en perneras Adjustable buckles in leg support Boucles réglables aux cuissardes



140 kg

Extensión

Aplicación Application Application	Anticaídas (EN 361) Fall arrest (EN 361) Antichute (EN 361)
Descripción Description Description	1 punto de anclaje anticaídas dorsal 1 fall arrest anchoring point 1 point d'ancrage anti-chutes dorsal Hebillas regulables en perneras Adjustable buckles in leg support Boucles réglables aux cuissardes Extensión dorsal en cinta de 40cm 40 cm dorsal strap extension Extension dorsale avec sangle de 40cm

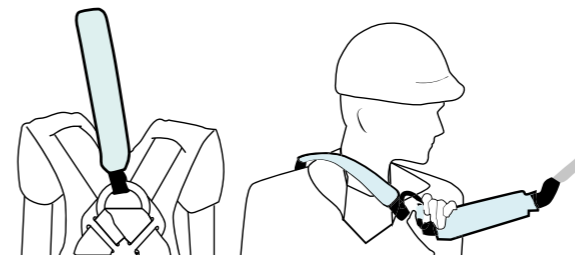



» ARNESES DE ASIENTO WAIST HARNESSES | HARNAIS CUISSARDS

» CINTURONES DE SUJECIÓN | WORK POSITIONING BELT | CEINTURES DE SOUTIEN

Atlas Basic



Aplicación Application Application	Posicionamiento (EN 358) / Suspensión (EN 813) Positioning (EN 358) / Suspension (EN 813) Positionnement (EN 358) / Suspension (EN 813)
	1 punto de anclaje de suspensión ventral 1 ventral attachment Point d'ancrage de suspension ventral
	Hebillas laterales abatibles de posicionamiento Lateral folding positioning buckles Boucles laterales de positionnement rabattables
Descripción Description Description	Hebillas de rápida actuación en banda de cintura y en perneras Quick-fit buckles on waistband and leg supports Boucles rapides au niveau de la taille et des cuissards
	Acolchamiento en banda de cintura y perneras Padding waist and legs Bande ceinture et cuissards matelassées.
	3 aros portamateriales 3 material holding rings 3 anneaux porte-outils

Atlas Tree Basic Arboricultura



Aplicación Application Application	Posicionamiento (EN 358) / Suspensión (EN 813) Positioning (EN 358) / Suspension (EN 813) Positionnement (EN 358) / Suspension (EN 813)
	Punto de anclaje de suspensión ventral Mobile ventral anchoring point point d'ancrage ventral mobile
	Hebillas laterales abatibles de posicionamiento Lateral folding positioning buckles Boucles laterales de positionnement rabattables
Descripción Description Description	Hebillas de rápida actuación en banda de cintura y en perneras Quick-fit buckles on waistband and leg supports Boucles rapides au niveau de la taille et des cuissards
	Acolchamiento en banda de cintura y perneras Padding waist and legs Bande ceinture et cuissards matelassées.
	3 aros portamateriales 3 material holding rings 3 anneaux porte-outils

24-C AT

Aplicación Application Application	Posicionamiento (EN 358) Positioning (EN 358) Positionnement (EN 358)
	2 hebillas laterales abatibles de posicionamiento 2 positioning folding lateral rings. 2 boucles latérales rabattables de positionnement
	1 hebilla de regulación 1 adjustable buckle 1 boucle réglable
Descripción Description Description	Refuerzo lumbar acolchado transpirable que aporta una máxima comodidad en sujeción Breathable padded lumbar reinforcement providing maximum comfort in position work Renfort lombaire rembourré respirant qui offre le maximum de confort lors de positionnement
	2 aros portamateriales 2 material holding rings 2 anneaux porte-outils
	Elemento de amarre regulable ø 12 mm 12 mm ø adjustable lanyard Élément d'amarrage réglable ø 12 mm



25-CN

Aplicación Application Application	Posicionamiento (EN 358) Positioning (EN 358) Positionnement (EN 358)
	2 hebillas laterales abatibles de posicionamiento 2 lateral folding positioning buckles 2 boucles laterales de positionnement rabattables
	1 hebilla de regulación 1 adjustable buckle 1 boucle réglable
Descripción Description Description	Banda lumbar transpirable Breathable padded lumbar Lombaire rembourré respirant
	Elemento de amarre regulable ø 12 mm 12 mm ø adjustable lanyard Élément d'amarrage réglable ø 12 mm





» **ABSORBEDORES DE ENERGÍA** | ENERGY ABSORBERS | ABSORBEURS D'ÉNERGIE

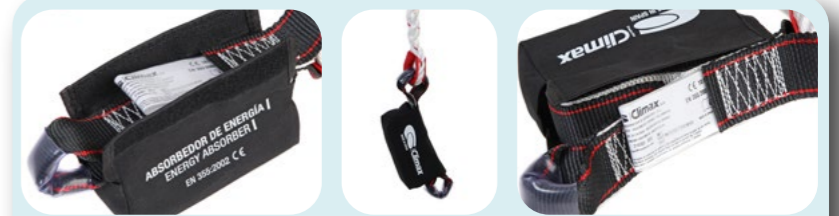

***Nueva bolsa protectora para los conjuntos absorbedores de energía**
* New protective bag for energy absorbing assemblies
* Nouveau sac de protection pour assemblages absorbeurs d'énergie

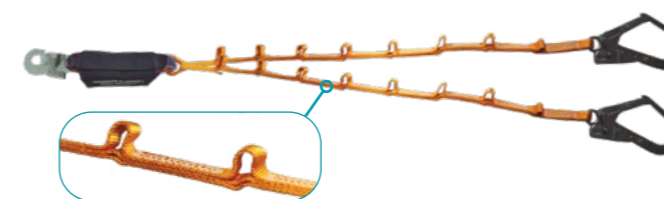

53 Bucles

Aplicación Application Application	Absorbedor de energía (EN 355) Energy absorber (EN 355) Absorbeur d'énergie (EN 355)
Descripción Description Description	<p>Incluye:</p> <ul style="list-style-type: none"> - 2 conectores modelo 31 (diámetro de abertura 51 mm) - 1 conector modelo 32 (diámetro de abertura de 18 mm) <p>Includes:</p> <ul style="list-style-type: none"> - 2 Climax 31 scaffolding hooks (gate opening 51 mm) - 1 Climax 32 scaffolding hook (gate opening 18 mm) <p>Comprend:</p> <ul style="list-style-type: none"> - 2 connecteurs modèle 31 (diamètre d'ouverture 51 mm) - 1 connecteur modèle 32 (diamètre d'ouverture 18 mm)

53 Bucles Dieléctrico

Aplicación Application Application	Absorbedor de energía (EN 355) Energy absorber (EN 355) Absorbeur d'énergie (EN 355)
Descripción Description Description	<p>Incluye:</p> <ul style="list-style-type: none"> - 2 conectores dieléctricos modelo 31 (diámetro de abertura 51 mm) - 1 conector dieléctrico modelo 32 (diámetro de abertura de 18 mm) <p>Includes:</p> <ul style="list-style-type: none"> - 2 Climax 31 scaffolding dielectrics hooks (gate opening 51 mm) - 1 Climax 32 scaffolding dielectric hook (gate opening 18 mm) <p>Comprend:</p> <ul style="list-style-type: none"> - 2 connecteurs diélectriques modèle 31 (diamètre d'ouverture 51 mm) - 1 connecteur diélectrique modèle 32 (diamètre d'ouverture 18 mm)

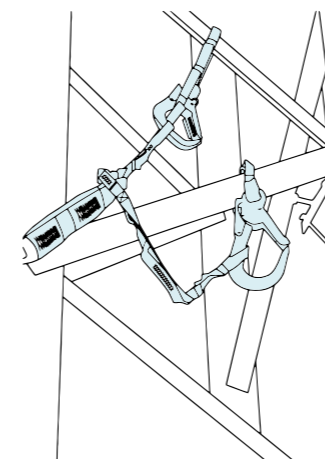

- **Abraza la estructura sin tener que estrangular la cinta.**
It embraces a structure with no need to strangle the webbing.
Il permet d'embrasser la structure sans étrangler la sangle.
- **Permiten ajustar la longitud de la cinta.**
It allows to shorten the webbing length.
Il permet de raccourcir la longueur de la sangle.
- **Permiten la instalación del absorbedor en estructuras con diámetro superior al del propio conector mod 31 (51 mm).**
It allows the installation of the absorber in structures with a diameter greater than that of the mod 31 connector (51 mm).
Il permet la installation de l'absorbeur dans des structures de diamètre supérieur à celui du connecteur mod 31 (51 mm).
- **Permite recortar la longitud del elemento de amarre.**
Allows you to shorten the length of the lanyard.
Vous permet de raccourcir la longueur de la longe.





53 Bucles Simple

Aplicación Application Application	Absorbedor de energía (EN 355) Energy absorber (EN 355) Absorbeur d'énergie (EN 355)
Incluye:	- 1 conector modelo 31 (diámetro de apertura 51 mm) - 1 conector modelo 32 (diámetro de apertura de 18 mm)
Includes:	- 1 Climax 31 scaffolding hook (gate opening 51 mm) - 1 Climax 32 scaffolding hook (gate opening 18 mm)
Comprend:	- 1 connecteur modèle 31 (diamètre d'ouverture 51 mm) - 1 connecteur modèle 32 (diamètre d'ouverture 18 mm)
Descripción Description Description	



53 Bucles Dieléctrico Simple

Aplicación Application Application	Absorbedor de energía (EN 355) Energy absorber (EN 355) Absorbeur d'énergie (EN 355)
Incluye:	- 1 conector dieléctrico modelo 31 (diámetro de apertura 51 mm) - 1 conector dieléctrico modelo 32 (diámetro de apertura de 18 mm)
Includes:	- 1 Climax 31 scaffolding dielectric hook (gate opening 51 mm) - 1 Climax 32 scaffolding dielectric hook (gate opening 18 mm)
Comprend:	- 1 connecteur diélectrique modèle 31 (diamètre d'ouverture 51 mm) - 1 connecteur diélectrique modèle 32 (diamètre d'ouverture 18 mm)
Descripción Description Description	



53 Arboricultura

Aplicación Application Application	Absorbedor de energía (EN 355) Energy absorber (EN 355) Absorbeur d'énergie (EN 355)
Incluye:	- 2 conectores modelo PCX-001 (diámetro de apertura 25 mm) - 1 conector modelo 32 (diámetro de apertura de 18 mm)
Includes:	- 2 Climax PCX-001 scaffolding hooks (gate opening 25 mm) - 1 Climax 32 scaffolding hook (gate opening 18 mm)
Comprend:	- 2 connecteurs modèle PCX-001 (diamètre d'ouverture 25 mm) - 1 connecteur modèle 32 (diamètre d'ouverture 18 mm)
Descripción Description Description	
	Incorpora maillon para la sustitución de los elementos de amarre. Quick link included for lanyard replacement Intègre maillon pour le remplacement des éléments d'amarrage



53 Arboricultura Simple

Aplicación Application Application	Absorbedor de energía (EN 355) Energy absorber (EN 355) Absorbeur d'énergie (EN 355)
Incluye:	- 1 conector modelo PCX-001 (diámetro de apertura 25 mm) - 1 conector modelo 32 (diámetro de apertura de 18 mm)
Includes:	- 1 Climax PCX-001 scaffolding hooks (gate opening 25 mm) - 1 Climax 32 scaffolding hook (gate opening 18 mm)
Comprend:	- 1 connecteurs modèle PCX-001 (diamètre d'ouverture 25 mm) - 1 connecteur modèle 32 (diamètre d'ouverture 18 mm)
Descripción Description Description	
	Incorpora maillon para la sustitución de los elementos de amarre. Quick link included for lanyard replacement Intègre maillon pour le remplacement des éléments d'amarrage



91

Aplicación Application Application	Absorbedor de energía (EN 355) Energy absorber (EN 355) Absorbeur d'énergie (EN 355)
Incluye:	- 2 conectores modelo 49 (diámetro de apertura 60 mm) - 1 conector modelo 30 (diámetro de apertura de 16 mm)
Includes:	- 2 Climax 49 scaffolding hooks (gate opening 60 mm) - 1 Climax 30 scaffolding hook (gate opening 16 mm)
Comprend:	- 2 connecteurs modèle 49 (diamètre d'ouverture 60 mm) - 1 connecteur modèle 30 (diamètre d'ouverture 16 mm)
Descripción Description Description	

Absorbedor con cuerda de poliamida en "Y" para trabajos con **distancia mínima de seguridad de 4 metros**. Medida total del absorbedor de 90cm. "Y" energy absorber with polyamide lanyard for work with a **minimum safety distance of 4 meters**. Total absorber measurement of 90cm. Absorbeur d'énergie en "Y" avec corde en polyamide pour les travaux avec une **distance de sécurité minimale de 4 mètres**. Mesure totale de l'absorbeur de 90 cm.

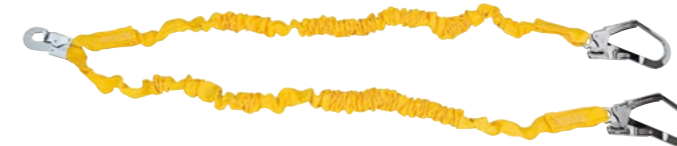

47 Doble

Aplicación Application Application	Absorbedor de energía (EN 355) Energy absorber (EN 355) Absorbeur d'énergie (EN 355)
Incluye:	- 2 conectores modelo 31 (diámetro de apertura 51 mm) - 1 conector modelo 32 (diámetro de apertura de 18 mm)
Includes:	- 2 Climax 31 scaffolding hooks (gate opening 51 mm) - 1 Climax 32 scaffolding hook (gate opening 18 mm)
Comprend:	- 2 connecteurs modèle 31 (diamètre d'ouverture 51 mm) - 1 connecteur modèle 32 (diamètre d'ouverture 18 mm)
Descripción Description Description	
	Absorbedor de cinta elástica de poliamida en Y de 1,40 cm. Prolongación elástica del absorbedor hasta 1,60 cm. 1,40 cm "Y" elastic strap polyamide energy absorber. Elastic extension of the absorber up to 1.60 cm. Absorbeur en "Y" de sangle élastique en polyamide de 1,40 cm. Extension élastique de l'absorbeur jusqu'à 1,60 cm.



90

Aplicación Application Application	Absorbedor de energía (EN 355) Energy absorber (EN 355) Absorbeur d'énergie (EN 355)
Incluye:	- 1 conectores modelo 49 (diámetro de apertura 60 mm) - 1 conector modelo 30 (diámetro de apertura de 16 mm)
Includes:	- 1 Climax 49 scaffolding hooks (gate opening 60 mm) - 1 Climax 30 scaffolding hook (gate opening 16 mm)
Comprend:	- 1 connecteurs modèle 49 (diamètre d'ouverture 60 mm) - 1 connecteur modèle 30 (diamètre d'ouverture 16 mm)
Descripción Description Description	

Absorbedor con cuerda de poliamida para trabajos con **distancia mínima de seguridad de 4 metros**. Medida total del absorbedor de 90cm. Energy absorber with polyamide lanyard for work with a **minimum safety distance of 4 meters**. Total absorber measurement of 90cm. Absorbeur d'énergie avec corde en polyamide pour les travaux avec une **distance de sécurité minimale de 4 mètres**. Mesure totale de l'absorbeur de 90 cm.

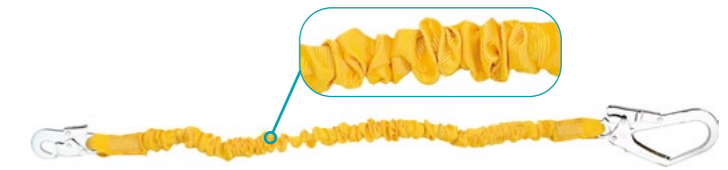

47-A

Aplicación Application Application	Absorbedor de energía (EN 355) Energy absorber (EN 355) Absorbeur d'énergie (EN 355)
Incluye:	- 1 conector modelo 31 (diámetro de apertura 51 mm) - 1 conector modelo 32 (diámetro de apertura de 18 mm)
Includes:	- 1 Climax 31 scaffolding hook (gate opening 51 mm) - 1 Climax 32 scaffolding hook (gate opening 18 mm)
Comprend:	- 1 connecteur modèle 31 (diamètre d'ouverture 51 mm) - 1 connecteur modèle 32 (diamètre d'ouverture 18 mm)
Descripción Description Description	
	Absorbedor de cinta elástica de poliamida de 1,40 cm. Prolongación elástica del absorbedor hasta 1,60 cm. 1,40 cm absorber of elastic polyamide. Elastic extension of the absorber up to 1.60 cm. Absorbeur d'énergie en polyamide élastique de 1,40 cm. Extension élastique de l'absorbeur jusqu'à 1,60 cm.



51

Aplicación Application Application	Absorbedor de energía (EN 355) Energy absorber (EN 355) Absorbeur d'énergie (EN 355)
Incluye:	- 2 conectores modelo 31 (diámetro de apertura 51 mm) - 1 conector modelo 32 (diámetro de apertura de 18 mm)
Includes:	- 2 Climax 31 scaffolding hooks (gate opening 51 mm) - 1 Climax 32 scaffolding hook (gate opening 18 mm)
Descripción Description Description	Comprend: - 2 connecteurs modèle 31 (diamètre d'ouverture 51 mm) - 1 connecteur modèle 32 (diamètre d'ouverture 18 mm)
	Elemento de amarre elástico en "Y" y absorbedor de energía de longitud de 1,30 cm con prolongación elástica hasta 1,90 cm. Elastic "Y" lanyard and energy absorber 1.30 cm long with elastic extension up to 1.90 cm. Élément d'amarrage élastique en "Y", et absorbeur d'énergie de 1,30 cm avec extension élastique jusqu'à 1,90 cm.

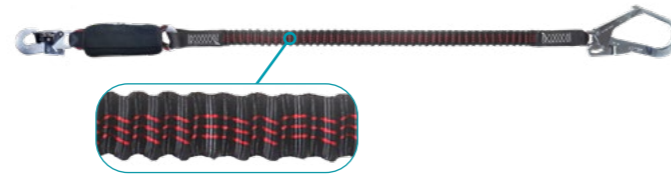

50

Aplicación Application Application	Absorbedor de energía (EN 355) Energy absorber (EN 355) Absorbeur d'énergie (EN 355)
Incluye:	- 1 conector modelo 31 (diámetro de apertura 51 mm) - 1 conector modelo 32 (diámetro de apertura de 18 mm)
Includes:	- 1 Climax 31 scaffolding hook (gate opening 51 mm) - 1 Climax 32 scaffolding hook (gate opening 18 mm)
Descripción Description Description	Comprend: - 1 connecteur modèle 31 (diamètre d'ouverture 51 mm) - 1 connecteur modèle 32 (diamètre d'ouverture 18 mm)
	Elemento de amarre elástico y absorbedor de energía de longitud de 1,30 cm con prolongación elástica hasta 1,90 cm. Elastic lanyard and energy absorber 1.30 cm long with elastic extension up to 1.90 cm. Élément d'amarrage et absorbeur d'énergie de 1,30 cm avec extension élastique jusqu'à 1,90 cm.



*** NUEVO * NEW * NOUVEAU**

35 Giro Semi

Aplicación Application Application	Absorbedor de energía (EN 355) Energy absorber (EN 355) Absorbeur d'énergie (EN 355)
Incluye:	- 2 conectores modelo 31 (diámetro de apertura 51 mm) - 1 conector modelo KH ALU (diámetro de apertura de 20 mm)
Includes:	- 2 Climax 31 scaffolding hooks (gate opening 51 mm) - 1 Climax KH ALU scaffolding hook (gate opening 20 mm)
Descripción Description Description	Comprend: - 2 connecteurs modèle 31 (diamètre d'ouverture 51 mm) - 1 connecteur modèle KH ALU (diamètre d'ouverture 20 mm)
	Absorbedor con cuerda de poliamida en "Y" "Y" energy absorber with polyamide lanyard Absorbeur d'énergie en "Y" avec corde en polyamide
	Eslabón giratorio para prevenir nudos Swivel to prevent knots Pivoter pour éviter les nœuds



34-A

Aplicación Application Application	Absorbedor de energía (EN 355) Energy absorber (EN 355) Absorbeur d'énergie (EN 355)
Incluye:	- 2 conectores modelo 31 (diámetro de apertura 51 mm) - 1 conector modelo 30 (diámetro de apertura de 16 mm)
Includes:	- 2 Climax 31 scaffolding hooks (gate opening 51 mm) - 1 Climax 30 scaffolding hook (gate opening 16 mm)
Descripción Description Description	Comprend: - 2 connecteurs modèle 31 (diamètre d'ouverture 51 mm) - 1 connecteur modèle 30 (diamètre d'ouverture 16 mm)
	Absorbedor con cinta de poliéster de 45 mm en "Y". "Y" energy absorber with 45 mm polyester tape. Absorbeur avec ruban en polyester de 45 mm en "Y".

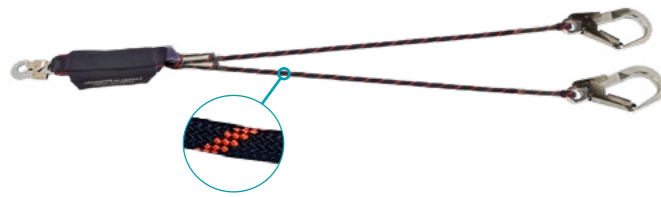

35 Semi

Aplicación Application Application	Absorbedor de energía (EN 355) Energy absorber (EN 355) Absorbeur d'énergie (EN 355)
Incluye:	- 2 conectores modelo 31 (diámetro de apertura 51 mm) - 1 conector modelo 32 (diámetro de apertura de 18 mm)
Includes:	- 2 Climax 31 scaffolding hooks (gate opening 51 mm) - 1 Climax 32 scaffolding hook (gate opening 18 mm)
Descripción Description Description	Comprend: - 2 connecteurs modèle 31 (diamètre d'ouverture 51 mm) - 1 connecteur modèle 32 (diamètre d'ouverture 18 mm)
	Absorbedor con cuerda de poliamida en "Y" "Y" energy absorber with polyamide lanyard Absorbeur d'énergie en "Y" avec corde en polyamide



37 Semi

Aplicación Application Application	Absorbedor de energía (EN 355) Energy absorber (EN 355) Absorbeur d'énergie (EN 355)
Incluye:	- 1 conectores modelo 31 (diámetro de apertura 51 mm) - 1 conector modelo 32 (diámetro de apertura de 18 mm)
Includes:	- 1 Climax 31 scaffolding hooks (gate opening 51 mm) - 1 Climax 32 scaffolding hook (gate opening 18 mm)
Descripción Description Description	Comprend: - 1 connecteurs modèle 31 (diamètre d'ouverture 51 mm) - 1 connecteur modèle 32 (diamètre d'ouverture 18 mm)
	Absorbedor con cuerda de poliamida Energy absorber with polyamide lanyard Absorbeur d'énergie avec corde en polyamide



35-A

Aplicación Application Application	Absorbedor de energía (EN 355) Energy absorber (EN 355) Absorbeur d'énergie (EN 355)
Incluye:	- 2 conectores modelo 31 (diámetro de apertura 51 mm) - 1 conector modelo 30 (diámetro de apertura de 16 mm)
Includes:	- 2 Climax 31 scaffolding hooks (gate opening 51 mm) - 1 Climax 30 scaffolding hook (gate opening 16 mm)
Descripción Description Description	Comprend: - 2 connecteurs modèle 31 (diamètre d'ouverture 51 mm) - 1 connecteur modèle 30 (diamètre d'ouverture 16 mm)
	Absorbedor con cuerda de poliamida de 14 mm en "Y" Energy absorber with polyamide 14 mm "Y" lanyard Absorbeur énergie avec élément d'amarrage en "Y" en polyamide 14 mm



37-A

Aplicación Application Application	Absorbedor de energía (EN 355) Energy absorber (EN 355) Absorbeur d'énergie (EN 355)
Incluye:	- 1 conector modelo 31 (diámetro de apertura 51 mm) - 1 conector modelo 30 (diámetro de apertura de 16 mm)
Includes:	- 1 Climax 31 scaffolding hook (gate opening 51 mm) - 1 Climax 30 scaffolding hook (gate opening 16 mm)
Descripción Description Description	Comprend: - 1 connecteurs modèle 31 (diamètre d'ouverture 51 mm) - 1 connecteur modèle 30 (diamètre d'ouverture 16 mm)
	Absorbedor con cuerda de poliamida de 14 mm Energy absorber with 14 mm polyamide lanyard. Absorbeur d'énergie avec élément d'amarrage 14 mm en polyamide





31-A

Aplicación Application Application	Absorbedor de energía (EN 355) Energy absorber (EN 355) Absorbeur d'énergie (EN 355)
Descripción Description Description	Absorbedor con cinta de poliéster de 45 mm. Energy absorber with 45 mm polyester tape. Absorbeur avec ruban en polyester de 45 mm.



32-A

Aplicación Application Application	Absorbedor de energía (EN 355) Energy absorber (EN 355) Absorbeur d'énergie (EN 355)
Descripción Description Description	A utilizar preferentemente con un elemento de amarre. Use preferably with a rope lanyard. À utiliser de préférence avec un élément d'amarrage. La longitud máxima admisible del absorbedor de energía incluido el elemento de amarre y los conectores no debe exceder de los 2 metros. The maximum permissible length of the energy absorber including lanyard and connectors must not exceed 2 meters. La longueur maximale autorisée de l'absorbeur d'énergie, cordon et connecteurs compris, ne doit pas dépasser 2 mètres.



Conjunto 39 Semi

Aplicación Application Application	Elementos de amarre (EN 354) Lanyards (EN 354) Éléments d'amarrage (EN 354)
Material Material Matière	Poliamida (11 mm) Polyamide (11 mm) Polyamide (11 mm)
Descripción Description Description	Incluye: - 1 conector modelo 31 (diámetro de abertura 51 mm) - 1 conector modelo 30 (diámetro de abertura de 16 mm) Incluye: - 1 Climax 31 scaffolding hook (gate opening 51 mm) - 1 Climax 30 scaffolding hook (gate opening 16 mm) Comprend: - 1 connecteur modèle 31 (diamètre d'ouverture 51 mm) - 1 connecteur modèle 30 (diamètre d'ouverture 16 mm) Varias medidas disponibles Many measures available Disponible en différentes mesures



Conjunto 39

Aplicación Application Application	Elementos de amarre (EN 354) Lanyards (EN 354) Éléments d'amarrage (EN 354)
Material Material Matière	Poliamida (14 mm) Polyamide (14 mm) Polyamide (14 mm)
Descripción Description Description	Incluye: - 1 conector modelo 31 (diámetro de abertura 51 mm) - 1 conector modelo 30 (diámetro de abertura de 16 mm) Incluye: - 1 Climax 31 scaffolding hook (gate opening 51 mm) - 1 Climax 30 scaffolding hook (gate opening 16 mm) Comprend: - 1 connecteur modèle 31 (diamètre d'ouverture 51 mm) - 1 connecteur modèle 30 (diamètre d'ouverture 16 mm) Varias medidas disponibles Many measures available Disponible en différentes mesures

» ELEMENTOS DE AMARRE | LANYARDS | ÉLEMENTS D'AMARRAGE



Conjunto 42 Semi

Aplicación Application Application	Elementos de amarre (EN 354) Lanyards (EN 354) Éléments d'amarrage (EN 354)
Material Material Matière	Poliamida (11 mm) Polyamide (11 mm) Polyamide (11 mm)
Descripción Description Description	Incluye: - 2 conectores modelo 31 (diámetro de abertura 51 mm) - 1 conector modelo 32 (diámetro de abertura de 18 mm) Incluye: - 2 Climax 31 scaffolding hooks (gate opening 51 mm) - 1 Climax 32 scaffolding hook (gate opening 18 mm) Comprend: - 2 connecteurs modèle 31 (diamètre d'ouverture 51 mm) - 1 connecteur modèle 32 (diamètre d'ouverture 18 mm) Varias medidas disponibles Many measures available Disponible en différentes mesures



Conjunto 40 Semi

Aplicación Application Application	Elementos de amarre (EN 354) Lanyards (EN 354) Éléments d'amarrage (EN 354)
Material Material Matière	Poliamida (11 mm) Polyamide (11 mm) Polyamide (11 mm)
Descripción Description Description	Incluye: - 1 conector modelo 31 (diámetro de abertura 51 mm) - 1 conector modelo 32 (diámetro de abertura de 18 mm) Incluye: - 1 Climax 31 scaffolding hook (gate opening 51 mm) - 1 Climax 32 scaffolding hook (gate opening 18 mm) Comprend: - 1 connecteur modèle 31 (diamètre d'ouverture 51 mm) - 1 connecteur modèle 32 (diamètre d'ouverture 18 mm) Varias medidas disponibles Many measures available Disponible en différentes mesures



Cu.29/1 Semi

Aplicación Application Application	Elementos de amarre (EN 354) Lanyards (EN 354) Éléments d'amarrage (EN 354)
Material Material Matière	Poliamida (11 mm) Polyamide (11 mm) Polyamide (11 mm)
Descripción Description Description	Se suministra según la elección del conector Is supplied according to the choice of connector Il est fourni selon le connecteur choisi Varias medidas disponibles Many measures available Disponible en différentes mesures



Cabo Anclaje Giro Semi

Aplicación Application Application	Elementos de amarre (EN 354) Lanyards (EN 354) Éléments d'amarrage (EN 354)
Material Material Matière	Poliamida (11 mm) Polyamide (11 mm) Polyamide (11 mm)
Descripción Description Description	Incluye: - 3 conectores modelo KH ALU (diámetro de abertura de 20 mm) Incluye: - 3 Climax KH ALU scaffolding hooks (gate opening 20 mm) Comprend: - 3 connecteurs modèle KH ALU (diamètre d'ouverture 20 mm) Varias medidas disponibles Many measures available Disponible en différentes mesures Eslabón giratorio para prevenir nudos Swivel to prevent knots Pivoter pour éviter les nœuds



Cu.29/1

Aplicación Application Application	Elementos de amarre (EN 354) Lanyards (EN 354) Éléments d'amarrage (EN 354)
Material Material Matière	Poliamida (14 mm) Polyamide (14 mm) Polyamide (14 mm)
Descripción Description Description	Se suministra según la elección del conector Is supplied according to the choice of connector Il est fourni selon le connecteur choisi Varias medidas disponibles Many measures available Disponible en différentes mesures



Conjunto 40

Aplicación Application Application	Elementos de amarre (EN 354) Lanyards (EN 354) Éléments d'amarrage (EN 354)
Material Material Matière	Poliamida (14 mm) Polyamide (14 mm) Polyamide (14 mm)
Descripción Description Description	<p>Incluye:</p> <ul style="list-style-type: none"> - 1 conector modelo 31 (diámetro de abertura 51 mm) - 1 conector modelo 32 (diámetro de abertura de 18 mm) <p>Includes:</p> <ul style="list-style-type: none"> - 1 Climax 31 scaffolding hook (gate opening 51 mm) - 1 Climax 32 scaffolding hook (gate opening 18 mm) <p>Comprend:</p> <ul style="list-style-type: none"> - 1 connecteur modèle 31 (diamètre d'ouverture 51 mm) - 1 connecteur modèle 32 (diamètre d'ouverture 18 mm) <p>Varias medidas disponibles Many measures available Disponible en différentes mesures</p>



Conjunto 42

Aplicación Application Application	Elementos de amarre (EN 354) Lanyards (EN 354) Éléments d'amarrage (EN 354)
Material Material Matière	Poliamida (14 mm) Polyamide (14 mm) Polyamide (14 mm)
Descripción Description Description	<p>Incluye:</p> <ul style="list-style-type: none"> - 2 conectores modelo 31 (diámetro de abertura 51 mm) - 1 conector modelo 32 (diámetro de abertura de 18 mm) <p>Includes:</p> <ul style="list-style-type: none"> - 2 Climax 31 scaffolding hooks (gate opening 51 mm) - 1 Climax 32 scaffolding hook (gate opening 18 mm) <p>Comprend:</p> <ul style="list-style-type: none"> - 2 connecteurs modèle 31 (diamètre d'ouverture 51 mm) - 1 connecteur modèle 32 (diamètre d'ouverture 18 mm) <p>Varias medidas disponibles Many measures available Disponible en différentes mesures</p>



Conjunto 44

Aplicación Application Application	Elementos de amarre (EN 354) Lanyards (EN 354) Éléments d'amarrage (EN 354)
Material Material Matière	Poliéster (45 mm) Polyester (45 mm) Polyester (45 mm)
Descripción Description Description	<p>Incluye:</p> <ul style="list-style-type: none"> - 2 conectores modelo 31 (diámetro de abertura 51 mm) - 1 conector modelo 32 (diámetro de abertura de 18 mm) <p>Includes:</p> <ul style="list-style-type: none"> - 2 Climax 31 scaffolding hooks (gate opening 51 mm) - 1 Climax 32 scaffolding hook (gate opening 18 mm) <p>Comprend:</p> <ul style="list-style-type: none"> - 2 connecteurs modèle 31 (diamètre d'ouverture 51 mm) - 1 connecteur modèle 32 (diamètre d'ouverture 18 mm) <p>Medidas / Lengths / Dimensions: 1 / 1,5 / 2 m</p>



45

Aplicación Application Application	Elementos de amarre (EN 354) Lanyards (EN 354) Éléments d'amarrage (EN 354)
Material Material Matière	Poliéster (45 mm) Polyester (45 mm) Polyester (45 mm)
Descripción Description Description	Medidas / Lengths / Dimensions: 1 / 1,5 / 2 m



46

Aplicación Application Application	Elementos de amarre (EN 354) Lanyards (EN 354) Éléments d'amarrage (EN 354)
Material Material Matière	Poliéster (45 mm) Polyester (45 mm) Polyester (45 mm)
Descripción Description Description	Medidas / Lengths / Dimensions: 1 / 1,5 / 2 m



» SISTEMAS DE POSICIONAMIENTO REGULABLE | ADJUSTABLE POSITIONING SYSTEM | SYSTÈMES DE POSITIONNEMENT RÉGLABLES



Cu.31 /1 Semi

Aplicación Application Application	Posicionamiento (EN 358) Positioning (EN 358) Positionnement (EN 358)
Descripción Description Description	<p>Incluye:</p> <ul style="list-style-type: none"> - 1 conector modelo PCX-001 (diámetro de abertura 25 mm) - 1 conector modelo 30 (diámetro de abertura de 16 mm) <p>Includes:</p> <ul style="list-style-type: none"> - 1 Climax PCX-001 scaffolding hook (gate opening 25 mm) - 1 Climax 30 scaffolding hook (gate opening 16 mm) <p>Comprend:</p> <ul style="list-style-type: none"> - 1 connecteur modèle PCX-001 (diamètre d'ouverture 25 mm) - 1 connecteur modèle 30 (diamètre d'ouverture 16 mm) <p>Cuerda de 14 mm con funda plástica protectora. Lanyard 14 mm with protective plastic cover Corde 14 mm avec plastique protecteur</p> <p>Varias medidas disponibles: 2m / 4m. Many measures available: 2m / 4m. Disponible en différentes mesures: 2m / 4m.</p>



Cu.31/1

Aplicación Application Application	Posicionamiento (EN 358) Positioning (EN 358) Positionnement (EN 358)
Descripción Description Description	<p>Incluye:</p> <ul style="list-style-type: none"> - 1 conector modelo 32 (diámetro de abertura 18 mm) - 1 conector modelo 30 (diámetro de abertura de 16 mm) <p>Includes:</p> <ul style="list-style-type: none"> - 1 Climax 32 scaffolding hook (gate opening 18 mm) - 1 Climax 30 scaffolding hook (gate opening 16 mm) <p>Comprend:</p> <ul style="list-style-type: none"> - 1 connecteur modèle 32 (diamètre d'ouverture 18 mm) - 1 connecteur modèle 30 (diamètre d'ouverture 16 mm) <p>Cuerda trenzada de 14 mm con funda plástica protectora. 14 mm braided lanyard with protective plastic cover Corde tressée de 14mm avec plastique protecteur</p> <p>Varias medidas disponibles: 2m / 4m. Many measures available: 2m / 4m. Disponible en différentes mesures: 2m / 4m.</p>



Cu.31/1 Tree Arboricultura

Aplicación Application Application	Posicionamiento (EN 358) Positioning (EN 358) Positionnement (EN 358)
Descripción Description Description	<p>Incluye:</p> <ul style="list-style-type: none"> - Conectores KH-GIRO (diámetro de abertura de 19 mm) - Conectores KH-ALU (diámetro de abertura de 20 mm) <p>Includes:</p> <ul style="list-style-type: none"> - KH-GIRO scaffolding hooks (gate opening 19 mm) - KH-ALU scaffolding hooks (gate opening 20 mm) <p>Comprend:</p> <ul style="list-style-type: none"> - Connecteurs KH-GIRO (diamètre d'ouverture de 19 mm) - Connecteurs KH-ALU (diamètre d'ouverture 20 mm) <p>Cable de acero recubierto de poliamida. Steel cable lanyard with polyamide coating. Câble d'acier recouvert de polyamide.</p> <p>Diámetro / Diameter / Diamètre: 8 mm</p> <p>Longitud / Length / Longueur: 2, 3, 4, 5 m</p>



Cu.30/1 Dieléctrico

Aplicación Application Application	Posicionamiento (EN 358) Positioning (EN 358) Positionnement (EN 358)
Descripción Description Description	<p>Incluye:</p> <ul style="list-style-type: none"> - 2 conectores modelo 32 dieléctrico (diámetro de abertura de 18 mm) <p>Includes:</p> <ul style="list-style-type: none"> - 2 dielectric scaffolding hooks mod. 32 (gate opening 18mm) <p>Comprend:</p> <ul style="list-style-type: none"> - 2 connecteurs diélectriques mod. 32 (diamètre d'ouverture 18 mm) <p>Elemento de posicionamiento regulable con hebillas dieléctricas. Positioning adjustable lanyard with dielectric buckles. Élément de positionnement réglable avec des boucles diélectriques</p>





140 kg

Cu.30/1 Semi

Aplicación Application Application	Posicionamiento (EN 358) Positioning (EN 358) Positionnement (EN 358)	
Material Material Matière	Poliamida (11 mm) Polyamide (11 mm) Polyamide (11 mm)	
Descripción Description Description	Varias medidas disponibles Many measures available Disponible en différentes mesures	
Longitud Length Longueur	Min. 0,8 m	Max. 1,35 m



140 kg

Cu.30/1

Aplicación Application Application	Posicionamiento (EN 358) Positioning (EN 358) Positionnement (EN 358)	
Material Material Matière	Poliamida (14 mm) Polyamide (14 mm) Polyamide (14mm)	
Descripción Description Description	Varias medidas disponibles Many measures available Disponible en différentes mesures	
Longitud Length Longueur	Min. 0,8 m	Max. 1,35 m

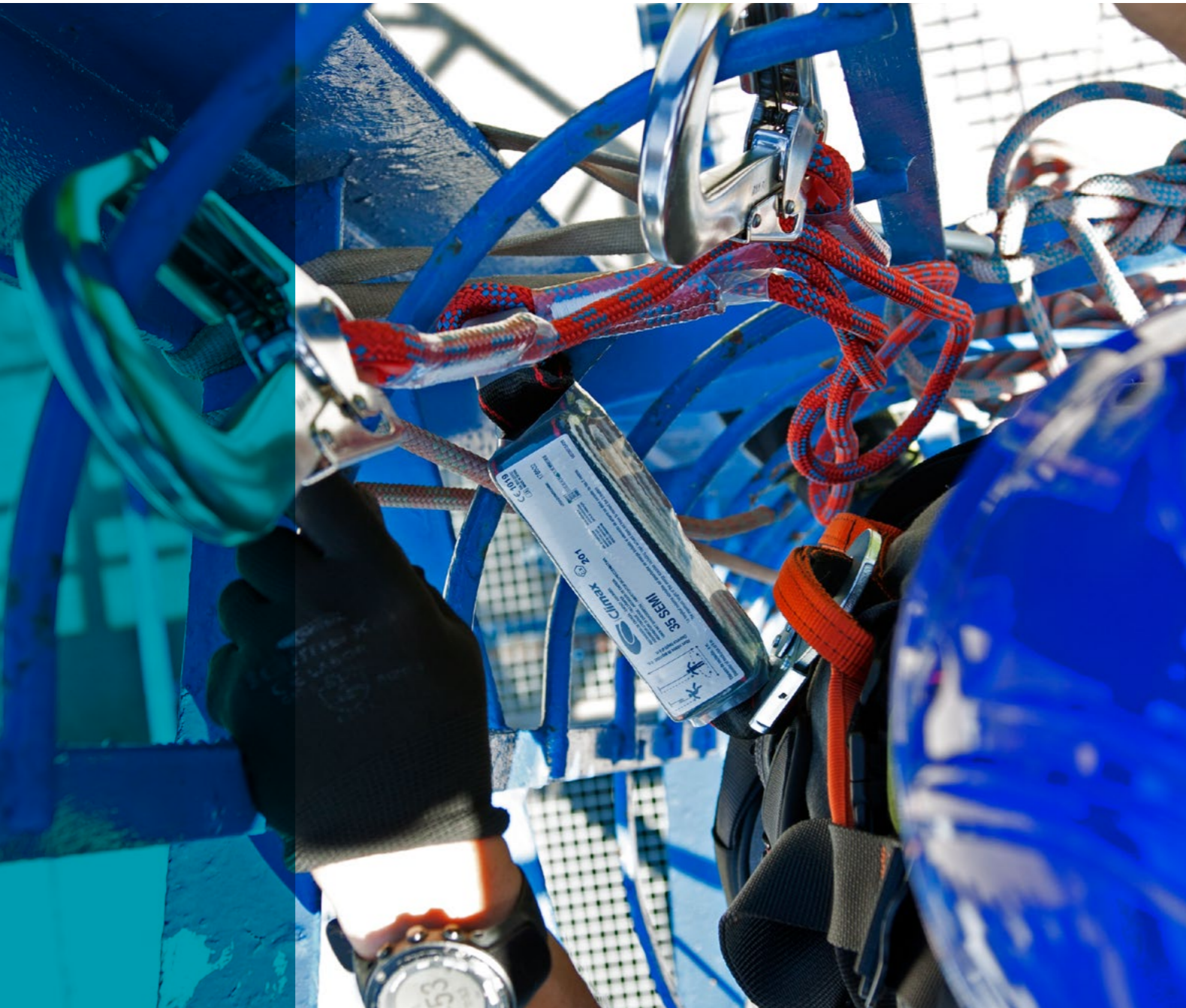

» CUERDA | ROPES | CORDES

Cuerda Semiestática

Aplicación Application Application	Línea de anclaje flexible Flexible anchoring line Ligne d'ancrage flexible
Diámetro Diameter Diámetro	11 mm
Material Material Matière	Poliamida Polyamide Polyamide
Acabados Finishings Finitions	Guardacabos para anclaje, nudos terminales o corte Thimble for anchorage, terminal knots or cut Boucle cousue pour ancrage, nœuds terminaux ou coupe
Longitud Length Longueur	A demanda Under request Sous demande
Norm	EN 1891



Guardacabos
Thimble
Boucle



A
CLASE
CLASS

Cuerda Dinámica

	8,9 ①	9,9 ①
Número de caídas Number of falls Nombre de chutes	5	7
Fuerza de impacto primera caída Impact force first fall Force d'impact première chute	7,9 kN	8,5 kN
Alargamiento dinámico Dynamic elongation Allongement dynamique	29,7%	33%
Diámetro Diameter Diámetro	8,9 mm	min 9,8 mm max 10,2 mm
Longitud Length Longueur	A demanda Under request Sous demande	A demanda Under request Sous demande
Norm	EN 892 / UIAA 101	EN 892 / UIAA 101

① ①/2 ②



Cuerda de Poliamida

Aplicación Application Application	Línea de anclaje flexible Flexible anchoring line Ligne d'ancrage flexible
Diámetro Diameter Diámetro	14 mm
Material Material Matière	Poliamida de 3 cabos 3 polyamide cape Polyamide à 3 câbles
Acabados Finishings Finitions	Lazada y nudo terminal o guardacabos en los extremos Loop and terminal knot or thimble at the ends Boucle et noeud terminal aux extrémités
Longitud Length Longueur	A demanda Under request Sous demande
Norm	UNE-EN ISO 1140:2012



Guardacabos
Thimble
Boucle





» **DISPOSITIVO DESCENSOR** | DESCENDER DEVICE | DISPOSITIF DESCENDEUR



*** NUEVO * NEW
* NOUVEAU**

PCXplorer

Normativa Norm Normatif	Uso Use Utiliser	Cuerda Rope Corde
EN 341:2011 Class A (30-180 kg)	Rescate Rescue Sauvetages	11 mm
EN 12841:2006 Type C (225 kg)	Sistema de acceso Rope acces Access system	10 mm < ϕ < 12 mm
EN 795:2012 Type B (225 kg)	Anclaje Anchoring Ancrage	Con cuerda WP With Landyard WP Avec corde WP
EN 15151-1:2012 Type B (225 kg)	Sistema de frenado semiautomático Belay device with asisted locking Système de freinage semi-automatique	8,9 mm < ϕ < 11,4 mm Cuerda dinámica simple / Simple dynamic rope / Corde dynamique simple 9 mm < ϕ < 12 mm Cuerda semiestática / Semi-static rope / Corde semi-statique
ANSI/ASSP Z359.4-2013 (59-141 kg)	Rescate Rescue Sauvetages	11 mm

- PCXplorer es un dispositivo multifuncional desarrollado para la realización de trabajos en suspensión vertical, rescate y como punto de anclaje móvil unipersonal (EN 795 clase B) en el ámbito laboral y para la realización de técnicas de alpinismo y asegurador en el ámbito deportivo.

PCXplorer is a multifunctional device developed for the performance of work in vertical suspension, rescue and as a single-person mobile anchor point (EN 795 class B) in the workplace and for the performance of mountaineering and insurance techniques in the sports field. PCXplorer est un appareil multifonctionnel développé pour effectuer des travaux en suspension verticale, en sauvetage et en tant que point d'ancrage mobile pour une personne (EN 795 classe B) sur le lieu de travail pour l'exécution des techniques d'alpinisme et d'assurance dans le domaine sportif.

- El dispositivo cuenta con un sistema de seguridad antipánico, que detiene el descenso en caso de presión excesiva en la palanca por parte del usuario. Cuenta con una función de bloqueo gradual para las fases de pausa y descenso. El accionamiento de la leva permite el deslizamiento de la cuerda de un modo bidireccional.

The device has a panic safety system, which stops the descent in case of excessive pressure on the lever by the user. It has a gradual blocking function for the pause and descent phases. The cam drive allows the rope to slide in a bidirectional way.

L'appareil dispose d'un système de sécurité anti-panique, qui arrête la descente en cas de pression excessive sur le levier par l'utilisateur. Il dispose d'une fonction de verrouillage progressif pour les phases de pause et de descente. L'actionnement de la came permet le glissement de la corde de manière bidirectionnelle.

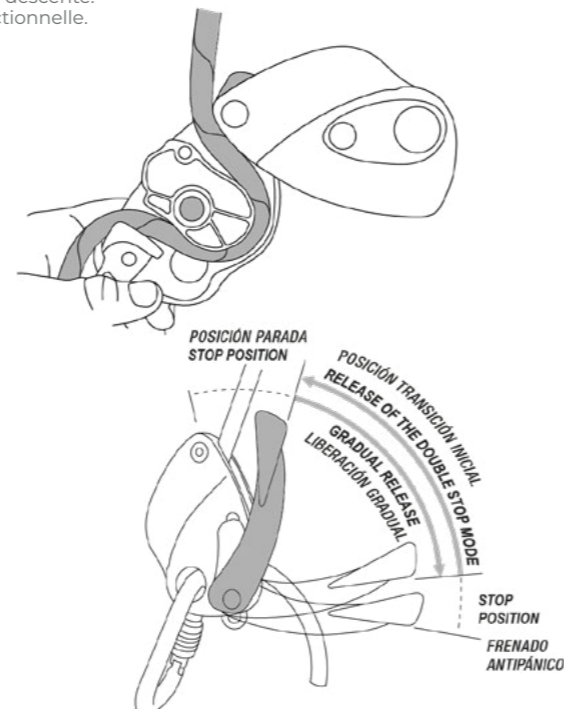
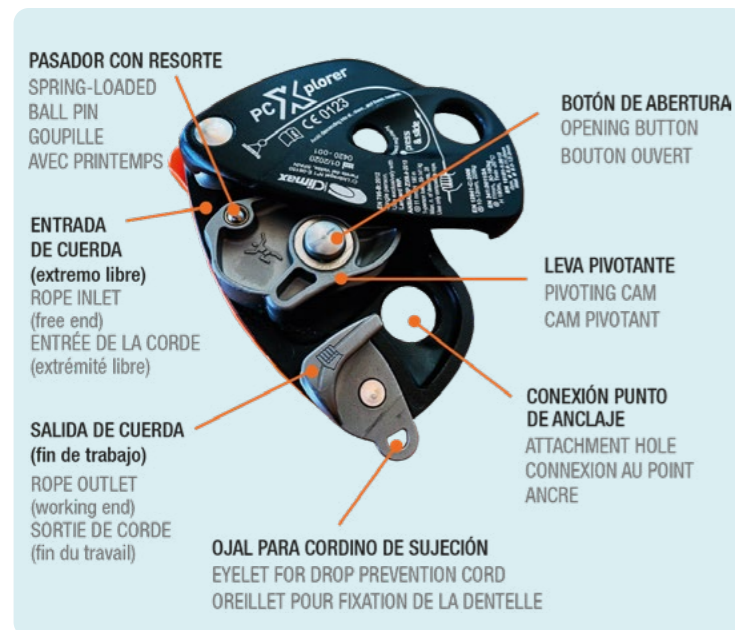

» **DISPOSITIVO ANTICAÍDAS DESLIZANTE** | GUIDED TYPE FALL ARRESTER | DISPOSITIFS ANTI-CHUTES COULISSANTS

Climax Roc

Diámetro Diameter Diàmetre	11 - 12,5 mm (EN 353-2)
Carga rotura Breakage load Résistance à la rupture	1.500 Kg
Material Material Matière	Aluminio Aluminium
Norm	EN 353-2



- El dispositivo anticaídas deslizante de cuerda puede ser equipado en cualquier punto de la cuerda, pudiendo usar el equipo durante el ascenso/descenso sin manipularlo. The guided type rope fall arrester can be fitted to the rope at any point and can be used hands-free when going up and down the rope. Le dispositif anti-chute glissant de corde peut s'attacher à n'importe quel point de la corde et il peut être utilisé à mains libres pendant l'ascension et la descente.
- En caso de caída se bloquea automáticamente. It locks automatically in the case of a fall. En cas de chute, il se bloque automatiquement.

- El dispositivo dispone de una pestaña de bloqueo de altura que permite al usuario autorescatarse en una caída. Funciona por pinzamiento de la cuerda y se desliza por ella en ascensión y descenso sin necesidad de manipular. The device has a height locking tab that allows the user to self-rescue in a fall. It works by clamping the rope and slides through it in ascension and descent without the need to manipulate. L'appareil dispose d'une languette de verrouillage en hauteur qui permet à l'utilisateur de se sauver lui-même en cas de chute. Il fonctionne en serrant la corde et glisse à travers elle en ascension et en descente sans avoir besoin de manipuler.

Otto

Diámetro Diameter Diàmetre	11 - 12 mm
Carga rotura Breakage load Résistance à la rupture	1.500 Kg
Material Material Matière	Aluminio Aluminium
Norm	EN 353-2

- En caso de caída se bloquea automáticamente. Automatic lock in case of fall. Blocage automatique en cas de chute.



A.D.A 14

Diámetro Diameter Diàmetre	14 mm
Carga rotura Breakage load Résistance à la rupture	1.500 Kg
Material Material Matière	Acero Steel Acier
Norm	EN 353-2

- Cierre de seguridad y sistema que evita la colocación errónea del equipo. Safety lock. System ensuring that equipment is installed properly. Fermeture de sécurité. Système que garantie la correcte utilisation de l'équipement.

- En caso de caída se bloquea automáticamente. Automatic lock in case of fall. Blocage automatique en cas de chute.



Kit Línea de vida vertical



Carga rotura Breakage load Résistance à la rupture	15 kg
Descripción Description Description	Incluye: - Cuerda de 11 mm - Conector mod. 49 - Apertura de 65 mm - Anticaídas Climax Roc - Extensión de cinta de poliéster de 16 mm - Conector KH Alu
	Inclues: - Rope 11 mm - Connector mod. 49 - Opening 65 mm - Climax Roc fall arrest device - 16mm polyester tape extension - KH Alu connector
Norm	Comprend: - Corde de 11 mm - Connecteur mod. 49 - Ouverture de 65 mm - Dispositif antichute Climax Roc - Rallonge de ruban polyester 16 mm - Connecteur KH Alu
	EN 353-2

- **Kit de línea de vida con dispositivo anticaídas antisalida.**
Lifeline kit with anti-exit fall arrest device.
Kit ligne de vie avec dispositif anti-chute anti-chute.



Cable

Diámetro Diameter Diàmetre	8 mm
Carga rotura Breakage load Résistance à la rupture	1.600 Kg
Material Material Matière	Acero Steel Acier
Norm	EN 353-2

- **Anticaídas extraíble para cable de acero inoxidable de diámetro 8 mm.**
Removable fall prevention device for stainless steel cable 8 mm.
Antichute extraíble pour cable en acier 8 mm.

- Fácil de montar y retirar del cable, sigue el desplazamiento del trabajador y se bloquea al momento de una caída.**
- Easy to mount and remove from the cable. It follows the user's movements and locks automatically in case of fall.
Facile à monter et à retirer du câble, suit le déplacement de l'utilisateur et blocage automatique en cas de chute.



» DISPOSITIVO RETRACTILES ANTICAÍDAS

| RETRACTABLE TYPE FALL ARRESTERS | DISPOSITIFS ANTI-CHUTES RÉTRACTABLES

10 M / 15 M / 20 M

Longitud Length Longueur	10/ 15/ 20 m
Peso Weight Poids	10 m = 4,8 Kg 15 m = 7 Kg 20 m = 8,8 Kg
Carga de trabajo en plano vertical Working load Charge de travail	120 Kg
Carga de trabajo en plano horizontal Working load Charge de travail	120 Kg
Norm	EN 360 RFU CNB/P/11.060



Incluye maletín de transporte
Includes carrying case
Comprend un étui de transport

- **Dispositivos anticaídas en cable de acero galvanizado de 4 mm de diámetro.**
Fall arrest device in 4 mm galvanized steel.
Dispositifs anti-chutes en câble en acier galvanisé de 4 mm de diamètre.

- **Equipados con un mosquetón de cierre manual por rosca y un mosquetón giratorio automático.**
Fitted with a manual screw closure and a automatic swivel carabiner.
Ils sont équipés d'un mousqueton manuel à fermeture fileté et d'un mousqueton rotatif automatique.

- **Aptos para su uso en el plano horizontal**
For use in the horizontal plane
Adaptés pour une utilisation sur plan horizontal

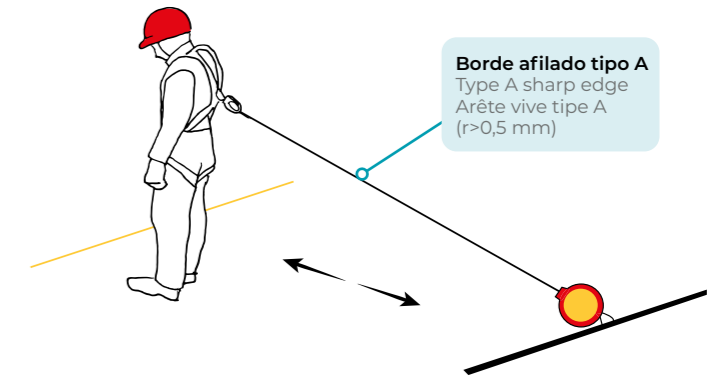

- **Los anticaídas retráctiles son dispositivos automáticos provistos de un sistema de frenado automático por inercia en el caso de caída.**
Retractable fall arrest systems are automatic devices with an automatic inertia braking system in the case of a fall.
Les anti-chutes automatiques sont des dispositifs pourvus d'un système de freinage automatique par inertie en cas de chute.

- **Una vez fijados a un punto de anclaje seguro permiten al usuario trabajar con la máxima movilidad, seguridad y confort en planos inclinados, tejados, torres, espacios confinados...**
These devices, once secured to a safe anchoring point, enable the user to work with the maximum mobility, safety and comfort on slopes, roofs, confined spaces...
Ces dispositifs une fois fixés à un point d'ancrage sécurisé permettent à l'utilisateur de travailler avec un maximum de mobilité, de sécurité et de confort sur des surfaces inclinées, toits, espaces confinés...

- **Especialmente recomendados cuando el pasillo de seguridad es mínimo.**
Specially recommended when the safety corridor is minimum.
Il sont tout particulièrement recommandés lorsque l'allée de sécurité est minime.



6M	
Longitud Length Longueur	6 m
Peso Weight Poids	2,75 Kg
Carga de trabajo en plano Working load Charge de travail	140 Kg
Norm	EN 360

- **Dispositivo anticaídas en cinta de 25 mm. de ancho.**
Fall arrest device in a 25 mm wide tape.
Dispositif anti-chutes en sangle de 25 mm de largeur.
- **Equipado con mosquetón Climax 30 y mosquetón automático giratorio.**
Fitted with a Climax 30 connector and an automatic swivel carabiner.
Équipé d'un mousqueton à fermeture fileté et d'un mousqueton automatique rotatif.



2,5 M	
Longitud Length Longueur	2,5 m
Peso Weight Poids	1,344 Kg
Carga de trabajo en plano Working load Charge de travail	100 Kg
Norm	EN 360

- **Dispositivo anticaídas retráctil.**
Retractable fall arrest device.
Dispositif anti-chutes rétractable.
- **Dispone de absorbedor de energía integrado.**
Integrated shock absorber.
Il dispose d'un absorbeur d'énergie intégré.
- **Se suministra con 2 conectores Climax 30.**
Supplied with 2 Climax 30 connectors.
Il est fourni avec 2 connecteurs Climax 30.



Horizont Complet 20M 30M

Ancho Width Largeur	35 mm	50 mm
Longitud máx. Max. length Longueur max.	20 m	30 m
Usuarios Users Utilisateurs	2 max.	3 max.
Material Material Matière	Poliéster Polyester Polyester	
Incluye Include Comprend	2 anillos de instalación 2 anchor rings 2 anneau d'ancrage 1 bolsa PVC PVC bag Sac PVC	
Versión Version Version	2 conectores KH Giro 2 connectors KH Giro 2 connecteurs KH Giro	A elegir: 2 conectores KH Giro o 2 conectores Climax 30 To choose: 2 connectors KH Giro or 2 connectors Climax 30 Au choix: 2 connecteurs KH Giro ou 2 connecteurs Climax 30
Norm	EN 795 CEN/TS 16415:2013	



- **El equipo incorpora una bolsa para recoger la cinta que no se utiliza y para proteger al ratchet de agentes externos.**
It includes a storage bag for the tape that is not being used, and protecting ratchet against external agents.
L'équipement comprend un sac de rangement pour le sangle non utilisée et pour protection du ratchet des agents extérieurs.
- **Los conectores de extremidad KH Giro son rotativos para evitar los nudos.**
The KH Giro end connectors are rotatable to avoid knots.
Les connecteurs d'extrémité KH Giro sont rotatifs pour éviter les nœuds.

» DISPOSITIVOS DE ANCLAJE | ANCHOR DEVICES | DISPOSITIF D'ANCRAGE



TIE-OFF PCX003	
Longitud Length Longueur	150 cm
Material Material Matière	Poliéster (90 mm) Polyester (90 mm) Polyester (90 mm)
Norm	EN 795



- **Punto de anclaje móvil diseñado para trabajos sobre apoyos de madera y hormigón.**
Mobile anchoring point designed to work on wood and concrete supports.
Point d'ancrage mobile conçu pour des travaux sur appuis en bois et béton.
- **Puede trabajar en tiro directo o bien por estrangulación.**
It can work straight or by strangulation.
Pour travailler directement ou par étranglement
- **Posibilidad de entrega en formato dieléctrico.**
Possibility of delivery in dielectric format.
Possibilité de livraison au format diélectrique

- **Gran resistencia a la abrasión.**
High abrasion resistance.
Grande résistance à l'abrasion.
- **Hebilla "D" metálica cincada para evitar la corrosión.**
Zinc coated "D" metal buckle to avoid corrosion.
Boucle métallique zinguée "en D" pour éviter la corrosion.
- **Refuerzo de poliéster de 45 mm de ancho.**
Reinforced with 45 mm polyester strap.
Renforcement en polyester de 45 mm de largeur.



Horizont 20M 30M

Ancho Width Largeur	35 mm	50 mm
Longitud máx. Max. length Longueur max.	20 m	30 m
Usuarios Users Utilisateurs	2 max.	3 max.
Material Material Matière	Poliéster Polyester Polyester	
Versión Version Version	A elegir: Sin conectores o 2 conectores Climax 30 To choose: No connectors or 2 Climax 30 connectors Au choix: Pas de connecteurs ou 2 connecteurs Climax 30	A elegir: 2 Conectores Climax 30 o 2 conectores KH Giro To choose: 2 Climax 30 connectors or 2 KH Giro connectors Au Choix: 2 connecteurs Climax 30 ou 2 connecteurs KH Giro
Norm	EN 795 CEN/TS 16415:2013	

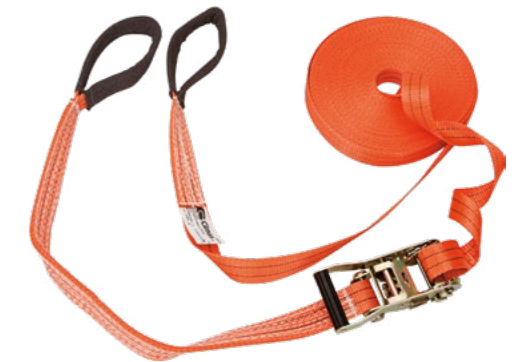

- **Los conectores de extremidad KH Giro (a elegir en Horizont 30M) son rotativos para evitar los nudos.**
The KH Giro end connectors (to choose on Horizont 30M) are rotatable to avoid knots.
Les connecteurs d'extrémité KH Giro (au choix sur Horizont 30M) sont rotatifs pour éviter les nœuds.



APX

Fuerza de carga Length Longueur	25 kN
Material Material Matière	Acero inoxidable Stainless steel Acier inoxydable
Diámetro Diameter Diamètre	12 mm
Norm	EN 795



- Incluye el tornillo expansivo M12.
Se puede comprar el tornillo por separado.
Includes expanding M12 screw.
Screw can be purchased separately.
Comprend une vis à expansion M12.
La vis peut être achetée séparément.



Anillo de instalación

Longitud Length Longueur	08 / 1,2 / 1,5 / 2 m
Material Material Matière	Poliamida Polyamide Polyamide
Diámetro Diameter Diamètre	19 mm
Norm	EN 795



- Dispositivo de anclaje para líneas de vida, instalaciones provisionales y autoaseguramiento.
Lifeline anchoring device, temporary installations and self-insurance.
Dispositif d'anclaje de lignes de vie, des installations temporaires et de auto-assurance.



PA-004

Longitud Length Longueur	1 m
Material Material Matière	Acero galvanizado Galvanised steel Acier galvanisé
Diámetro Diameter Diamètre	8 mm
Norm	EN 795



- Puede usarse como elemento de amarre (EN354) o como elemento de anclaje móvil (EN795).
It can be used as a lanyard (EN 354) or as a mobile anchoring item (EN 795).
Il peut être utilisé comme éléments d'amarrage (EN 354) ou comme élément d'anclaje mobile (EN 795).

- Cable de acero recubierto de tubo de plástico.
Steel cable coated with plastic tube.
Câble en acier revêtu d'un tube en plastique.

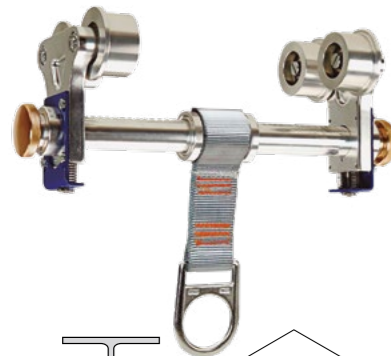

Vigadur

Material Material Matière	Aluminio Aluminum alloy Aluminium
Abertura Beam flange range Ouverture	76 - 255 mm
Usuarios Users Utilisateurs	1 max.
Norm	EN 795



- Punto de anclaje móvil deslizante utilizado en estructuras de vigas metálicas, proporcionando un anclaje fijo o temporal.
Mobile sliding anchoring point used in metal beam structures, providing permanent or temporary anchoring attachment.
Point d'anclaje mobile coulissant pour une utilisation sur des structures de poutres métalliques, qui permet un ancrage fixe ou temporaire.

- El sistema de ajuste se activa mediante pulsadores.
The adjustment system is activated by pushbuttons.
Le système de réglage s'actionne à l'aide de poussoirs.

- Incorpora una hebilla D de gran diámetro que facilita la conexión de todo tipo de conectores. Para un solo usuario.
It includes a large diameter D buckle for easy connection to all types of connector. Only individual use.
Comporte une boucle en D de grand diamètre qui facilite la connexion de tout type de connecteur.
Utilisation individuelle uniquement.

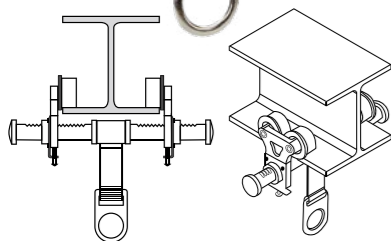

PA-002

Longitud Length Longueur	1 m
Material Material Matière	Poliéster (35 mm) Polyester (35 mm) Polyester (35 mm)
Norm	EN 795



- Su diseño permite ser utilizado como punto de anclaje durante la instalación de líneas de vida verticales en escaleras móviles o bien para la autoprotección del usuario durante el ascenso a estructuras.
Its design allows this to be used as anchoring point when installing vertical lifelines on mobile stairs or for self-protection of the user while ascending to structures.
Sa conception permet une utilisation en tant que point d'ancrage lors de l'installation de lignes de vie verticales sur des échelles mobiles ou bien pour l'autoprotection de l'utilisateur lors des ascensions à des structures.

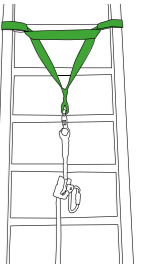

Bayoneta 6 M / 9 M

Longitud replgada Length closed Longueur en position repliée	6M 1,70 m 9M 2 m
Longitud extendida Length extended Longueur en position dépliée	6M 5,97 m 9M 8,75 m
Peso Weight Poids	6M 3,4 Kg 9M 5,2 Kg
Norm	EN 795

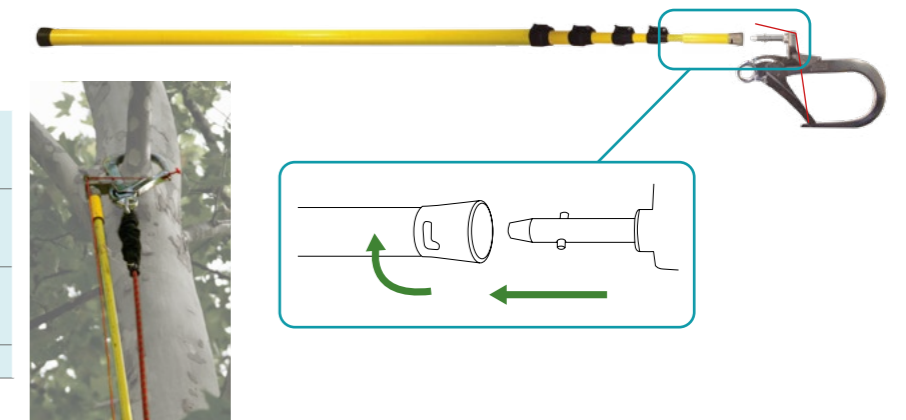

- Pértiga extensible en formato dieléctrico, mediante un conector de 100 mm por sistema bayoneta. Es posible el abandono del conector una vez instalado para poder utilizar otro conector.
Extendable pole in dielectric format, by means of a 100 mm connector by bayonet system. It is possible to abandon the connector once installed to be able to use another connector.
Comprend une vis à expansion.
Mât extensible au format diélectrique, au moyen d'un connecteur 100 mm par système à baïonnette. Il est possible d'abandonner le connecteur une fois installé pour pouvoir utiliser un autre connecteur.

Sistema P 6 M / 9 M

Longitud replgada Length closed Longueur en position repliée	6M 1,70 m 9M 2 m
Longitud extendida Length extended Longueur en position dépliée	6M 5,97 m 9M 8,75 m
Peso Weight Poids	6M 3,4 Kg 9M 5,2 Kg
Máx. tensión nominal extendida Working voltage Tension nominale de travail	480 KW
Norm	EN 795

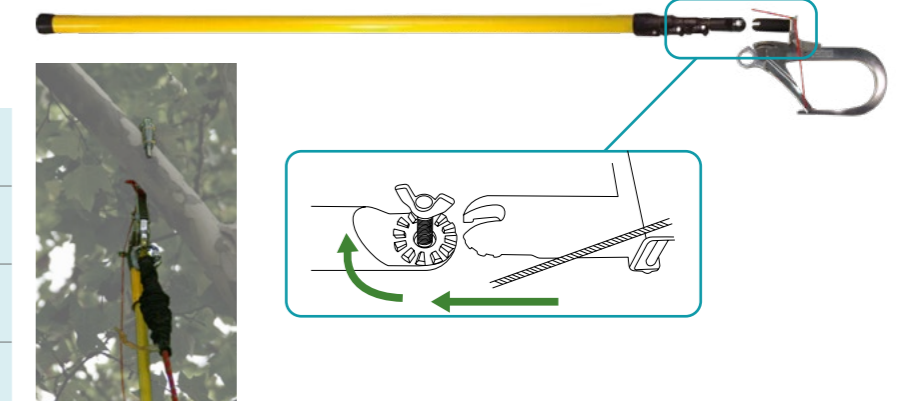

- Pértiga extensible en formato dieléctrico, mediante un conector de 100 mm por sistema de fijación de tipo palometa. No es posible la desconexión del conector durante la utilización.
Extendable pole in dielectric format, by means of a 100 mm connector by means of a wing-type fixing system. It is not possible to disconnect the connector during use.
Comprend une vis à expansion.
Mât extensible au format diélectrique, au moyen d'un connecteur de 100 mm au moyen d'un système de fixation en forme d'aile. Il n'est pas possible de déconnecter le connecteur pendant l'utilisation.



» RESCATE | RESCUE | SECOURS

- 1 RESCATE EN ALTURA | RESCUE AT HEIGHT | SAUVETAGE EN HAUTEUR
2 TRABAJO Y RESCATE EN ESPACIOS CONFINADOS | WORK AND RESCUE IN CONFINED SPACES | TRAVAIL ET SAUVETAGE DANS DES ESPACES CONFINÉS



1 *NUEVO *NEW *NOUVEAU

Kit Rescate
Pcxplorer 25M D8,9

Descripción Description Description	Incluye: - PCXplorer - Anillos de cinta - 2 conectores KH-ALU o PCX-002 (a elegir) - Cuerda dinámica - Petate 5 L Includes: - PCXplorer - Tape rings - 2 hooks KH-ALU or PCX-002 (to choose) - Dynamic rope - 5 L carry bag Comprend: - PCXplorer - Anneaux de ruban - 2 connecteurs KH-ALU ou PCX-002 (au choix) - Corde dynamique - Sac 5 L
	Norm EN 341 Clase / Class A EN 362 EN 795 EN 892

- Equipo de aseguramiento acompañado, evacuación y rescate, donde se deba asegurar o evacuar en tramos de pendiente o en tramos técnicos.
Accompanied belay equipment, evacuation and rescue, where it is necessary to secure or evacuate on slopes or technical sections.
Matière d'assurage, d'évacuation et de sauvetage accompagné, où il est nécessaire de sécuriser ou d'évacuer sur des pistes ou des sections techniques.
- Descensos y ascensos cortos.
Short descents and ascents.
Courtes descentes et montées.

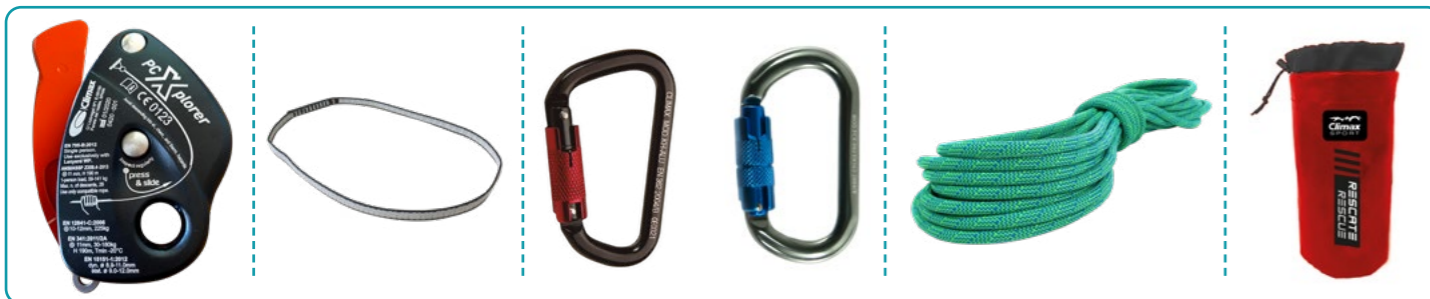

- Dispositivo de descenso multifuncional.
Multifunctional lowering device.
Dispositif d'abaissement multifonctionnel.
- Anillo de cinta para equipar reuniones, reducir la fricción de la cuerda, anclajes...
Tape ring to equip belay stations, reduce rope friction, anchors...
Anneau de ruban pour équiper les réunions, réduire les frottements de corde, ancrages...
- Conector de seguridad automático (x2)
Automatic safety connector (x2)
Connecteur de sécurité automatique (x2)
A elegir / To choose / Au choix:
● KH-ALU 20 mm abertura
Opening 20 mm
Ouverture de 20 mm
3 movimientos
3 mouvements
● PCX-002 19 mm abertura
Opening 19 mm
Ouverture de 19 mm
2 movimientos
2 mouvements
- Cuerda dinámica de alta capacidad de absorción de impactos.
Dynamic rope with high shock absorption capacity.
Corde dynamique à haute capacité d'absorption des chocs.
- Bolsa portamateriales de 5 L.
Handle tool bag of 5 L.
Sac de matière de 5 L.

Trípode Portátil 2

Material Material Matière	Aluminio Aluminium Aluminium
Altura de trabajo ajustable (H) Adjustable working height (H) Hauteur de travail réglable (H)	135 -240 cm
Diámetro ajustable (D) Adjustable diameter (D) Diamètre réglable (D)	114 -210 cm
Peso Weight Poids	33 Kg
Carga de trabajo Working load FRA	100 Kg
Norm	EN 795 B EN 1496 A

B CLASE CLASS
A CLASE CLASS



- Longitud máxima del torno de rescate: 20 m.
Maximum length of the rescue winch: 20 m.
Longueur maximale du treuil de sauvetage: 20 m.
- Cable de acero galvanizado de 5 mm.
5 mm galvanized wire diameter.
Câble en acier galvanisé de 5 mm.
- Apto para 2 personas.
Suitable for 2 people.
Convient pour 2 personnes.

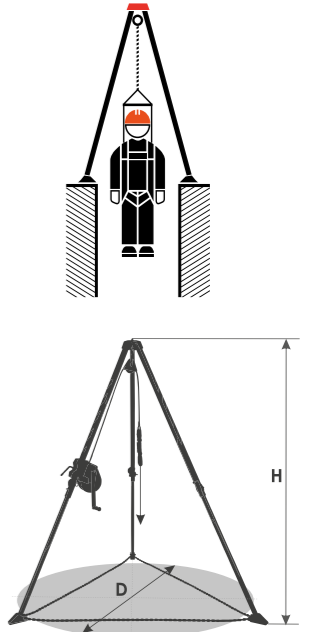

- Se suministra con bolsa de transporte.
Supplied with carrying bag.
Livré avec sac de transport.



Arnés de rescate 2

Arnés anticaídas diseñado para facilitar la evacuación del usuario en caso de emergencia.
Fall arrest harness designed to facilitate evacuation of the user in case of emergency.
Harnais anti-chutes conçu pour faciliter l'évacuation de l'utilisateur en cas d'urgence.

Norm EN 361



Dispositivo de rescate 2

Se debe utilizar en combinación con el arnés de rescate.
Webbing Strap to get a better comfortable position in a rescue operation.
Il doit s'utiliser avec un harnais d'extraction.





1 2 Triángulo de rescate

Aplicación Application Application	Rescates y operaciones de evacuación de corta duración For short-duration rescue and evacuation operations Pour sauvetages et opérations d'évacuation de courte durée
Material Material Matière	Lona y Poliéster Polyester Polyester

- **Incorpora 3 hebillas D metálicas.**
Contains 3 metallic D-rings.
Comprend 3 boucles D métalliques.



1 2 Camilla de rescate

Capacidad de carga máxima Max. Load limit Capacité de charge maximale	150 Kg
Peso Weight Poids	20 Kg
Medida Measure Mesurer	219 x 64 x 18 cm

- **Camilla de rescate tanto para ámbitos en vertical como en horizontal.**
Rescue stretcher for both vertical and horizontal areas.
Brancard de sauvetage pour les zones verticales et horizontales.

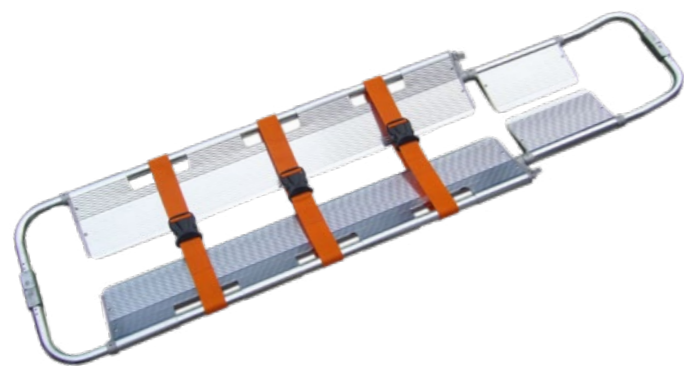

1 2 Camilla de aluminio

Capacidad de carga máxima Max. Load limit Capacité de charge maximale	150 Kg
Material Material Matière	Aluminio Aluminium Aluminium
Peso Weight Poids	8 Kg
Medida Measure Mesurer	214 x 42 x 7 cm

» DISPOSITIVO ANTITRAUMA | TRAUMA PREVENTION | DISPOSITIF ANTI TRAUMATISME



Dispositivo antitrauma

El dispositivo antitrauma está formado por dos bolsas que llevan en su interior una cinta y un sistema de unión entre ellas. Las cintas ofrecen un estribo al trabajador suspendido para apoyar el peso del cuerpo, aliviando la presión que ejerce el arnés sobre las ingles.

The trauma prevention device is made up of two bags containing a strap band union between them. The safety straps allow the user to stand up in the harness while suspended to relieve the pressure on thighs.

Le dispositif anti-traumatisme est formé par deux sacs contenant une sangle et une bande d'union entre elles. Les sangles fournissent un appui à l'utilisateur suspendu qui lui permet d'appuyer tout le poids de son corps, soulageant ainsi la pression exercée par le harnais au niveau de la région des aines.

Su diseño compacto y ligero no supone ninguna molestia al trabajador durante el desempeño de sus labores.

Its compact and lightweight design means no discomfort to the user while performing his work. Sa conception compacte et légère n'implique aucune gêne pour l'utilisateur lors du déroulement des travaux.

Cintas regulables. Longitud máxima 130 cm.
Adjustable safety straps. Max. Length: 130 cm.
Sangles réglables. Longueur maximale 130 cm.

Permite el movimiento de las piernas para favorecer la circulación de la sangre.
It allows the movement of the legs to help the blood circulation.
Il permet le mouvement des jambes pour favoriser la circulation du sang.

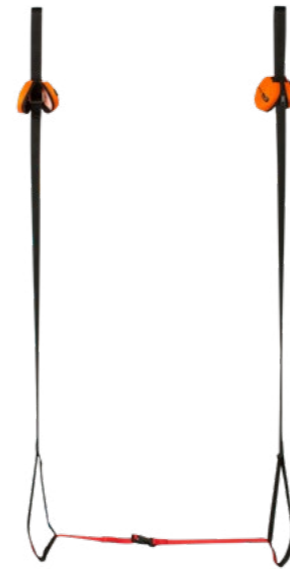

Pedal de Yuma
Foot-loop
Pédale réglable en sangle

Pedal con peldaños
Step foot-loop
Étrier quatre marches

- **Se conecta al bloqueador de puño para la realización de la maniobra de ascenso por cuerda.**
It attaches to the handled rope clamp for rope ascents.
Se connecte au bloqueur de poing pour la réalisation de la manoeuvre d'ascension à la corde.

- **Incorpora un maillon para la conexión con el bloqueador.**
It incorporates a quick link for connection to the rope clamp.
Elle incorpore un maillon de connexion au bloqueur.

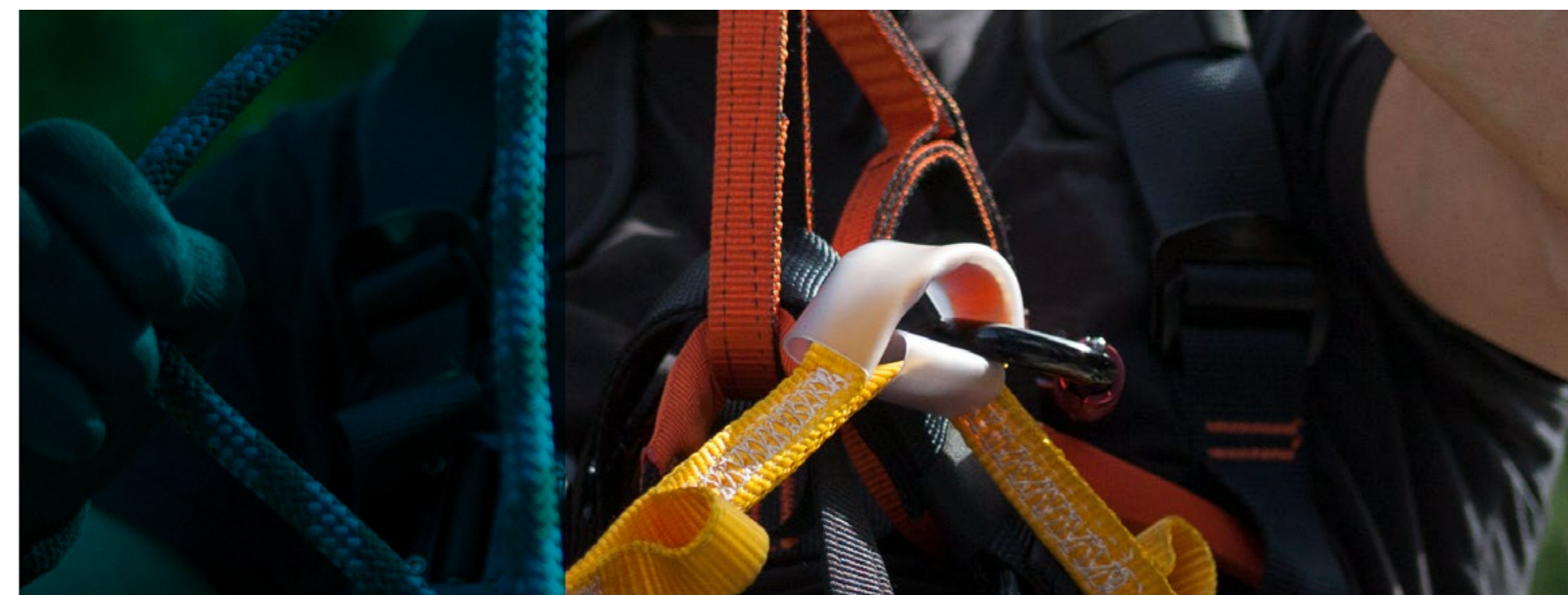



» **CONECTORES** | CONNECTORS | CONNECTEURS



30

Material Material Matière	Aleación de acero Alloy steel Allier acier
Diámetro de abertura Gate opening Diamètre d'ouverture	16 mm
Carga de rotura Breaking load Charge de rupture	25 kN
Peso Weight Poids	176 g
Norm	EN 362



31

Material Material Matière	Aleación de acero Alloy steel Allier acier
Diámetro de abertura Gate opening Diamètre d'ouverture	51 mm
Carga de rotura Breaking load Charge de rupture	23 kN
Peso Weight Poids	250 g
Norm	EN 362



32

Material Material Matière	Aleación de acero Alloy steel Allier acier
Diámetro de abertura Gate opening Diamètre d'ouverture	18 mm
Carga de rotura Breaking load Charge de rupture	23 kN
Peso Weight Poids	250 g
Norm	EN 362



PCX-001

Material Material Matière	Aluminio Aluminium Aluminium
Diámetro de abertura Gate opening Diamètre d'ouverture	25 mm
Carga de rotura Breaking load Charge de rupture	33 kN
Peso Weight Poids	135 g
Norm	EN 362



PCX-002

Material Material Matière	Aluminio Aluminium Aluminium
Diámetro de abertura Gate opening Diamètre d'ouverture	19 mm
Carga de rotura Breaking load Charge de rupture	23 kN
Peso Weight Poids	82 g
Norm	EN 362



49

Material Material Matière	Aluminio Aluminium Aluminium
Diámetro de abertura Gate opening Diamètre d'ouverture	60 mm
Carga de rotura Breaking load Charge de rupture	23 kN
Peso Weight Poids	530 g
Norm	EN 362



Delta

Material Material Matière	Aleación de acero Alloy steel Allier acier	
	8	10
Diámetro de abertura Gate opening Diamètre d'ouverture	9 mm	11 mm
Carga de rotura Breaking load Charge de rupture	25 kN	30 kN
Peso Weight Poids	87 g	148 g
Norm	EN 362	



KH

Material Material Matière	Aleación de acero Alloy steel Allier acier
Diámetro de abertura Gate opening Diamètre d'ouverture	24 mm
Carga de rotura Breaking load Charge de rupture	45 kN
Peso Weight Poids	250 g
Norm	EN 362



Oval

Material Material Matière	Aleación de acero Alloy steel Allier acier	
	8	10
Diámetro de abertura Gate opening Diamètre d'ouverture	10 mm	12 mm
Carga de rotura Breaking load Charge de rupture	25 kN	40 kN
Peso Weight Poids	76 g	143 g
Norm	EN 362	



MAXI

Material Material Matière	Aluminio Aluminium Aluminium
Diámetro de abertura Gate opening Diamètre d'ouverture	110 mm
Carga de rotura Breaking load Charge de rupture	22 kN
Peso Weight Poids	924 g
Norm	EN 362



KH ALU

Material Material Matière	Aluminio Aluminium Aluminium
Diámetro de abertura Gate opening Diamètre d'ouverture	20 mm
Carga de rotura Breaking load Charge de rupture	22 kN
Peso Weight Poids	92 g
Norm	EN 362



31 Dieléctrico

Material Material Matière	Acero recubierto de plástico Plastic coated steel Acier revêtu en plastique
Diámetro de abertura Gate opening Diamètre d'ouverture	51 mm
Carga de rotura Breaking load Charge de rupture	23 kN
Peso Weight Poids	580 g
Norm	EN 362



KH Giro

Material Material Matière	Aleación de acero Alloy steel Allier acier
Diámetro de abertura Gate opening Diamètre d'ouverture	19 mm
Carga de rotura Breaking load Charge de rupture	20 kN
Peso Weight Poids	450 g
Norm	EN 362



50

Material Material Matière	Aleación de acero Alloy steel Allier acier
Diámetro de abertura Gate opening Diamètre d'ouverture	19 mm
Carga de rotura Breaking load Charge de rupture	23 kN
Peso Weight Poids	275 g
Norm	EN 362



32 Dieléctrico

Material Material Matière	Acero recubierto de plástico Plastic coated steel Acier revêtu en plastique
Diámetro de abertura Gate opening Diamètre d'ouverture	18 mm
Carga de rotura Breaking load Charge de rupture	23 kN
Peso Weight Poids	220 g
Norm	EN 362



» BLOQUEADORES, POLEAS Y PLACAS MULTIANCLAJE

| BLOCKERS, PULLEYS & ANCHORS PLATE | BLOQUEURS, POULIES ET PLAQUES MULTI-ANCRAGES



Saryu

Material Material Matière	Aluminio Aluminium Aluminium
Diámetro de trabajo Working diameter Diamètre de travail	8-13 mm
Tipo Type Type	Bloqueador de mano Hand blocker Bloqueur de main
Peso Weight Poids	245 g
Norm	EN 567



Nahuel

Material Material Matière	Aluminio Aluminium Aluminium
Diámetro de trabajo Working diameter Diamètre de travail	8-13 mm
Tipo Type Type	Bloqueador de mano Hand blocker Bloqueur de main
Peso Weight Poids	170 g
Norm	EN 567



Newen

Material Material Matière	Aluminio Aluminium Aluminium
Diámetro de trabajo Working diameter Diamètre de travail	8-13 mm
Tipo Type Type	Bloqueador de pecho Chest blocker Bloqueur de poitrine
Peso Weight Poids	134 g
Norm	EN 567



M

Ø orificio de anclaje Anchor hole Ø Ø orifice d'ancrage	40 mm
Ø orificio de trabajo Rigging hole Ø Ø orifice de travail	22 mm
Carga de rotura mínima Minimum breaking load Charge de rupture minimale	36 kN
Peso Weight Poids	66 g



L

Ø orificio de anclaje Anchor hole Ø Ø orifice d'ancrage	40 mm
Ø orificio de trabajo Rigging hole Ø Ø orifice de travail	22 mm
Carga de rotura mínima Minimum breaking load Charge de rupture minimale	40 kN
Peso Weight Poids	223 g



AP-010

Max. Ø cuerda Max. rope Ø Ø corde	12 mm
Carga de rotura mínima Minimum breaking load Charge de rupture minimale	20 kN
Peso Weight Poids	91 g
Norm	EN 12278



AP-020

Max. Ø cuerda/cable Max. rope/cable Ø Max. Ø corde/câble	13 mm
Carga de rotura mínima Minimum breaking load Charge de rupture minimale	28 kN
Peso Weight Poids	237 g
Norm	EN 12278



Polea Bloqueadora

Ø cuerda Rope Ø Ø corde	8-13 mm
Límite de carga de trabajo Working load limit Charge limite de travail	5 kN
Peso Weight Poids	400 g
Norm	EN 567 EN 12278



» COMPLEMENTOS | ACCESSORIES | ACCESSOIRES



Asiento para trabajos de suspensión vertical

Material Material Matière	Madera Material: wood Matière: bois
Dimensiones Dimensions Mesures	40 x 40 cm

Silla rígida de madera para trabajos verticales.
Rigid wooden seat for vertical suspension work.
Siège rigide en bois pour travaux verticaux.

Ha de usarse imperativamente con arnés anticaídas, y suele combinarse con dispositivos de ayuda al ascenso/descenso.
It is imperative to use with a fall protection harness, and it's often combined with support devices for climb / descent.
Il est normalement utilisé avec des dispositifs d'aide à la montée / descente.



Asiento de suspensión prolongada

Material Material Matière	Madera Material: wood Matière: bois
Dimensiones Dimensions Mesures	67 x 24 cm

Acolchamiento en glúteos
Padded buttocks
Fesse matelassée

3 argollas portamateriales
3 material holding rings
3 anneaux port-outils

Longitud de cinta regulable
Adjustable tape length
Bande à longueur réglable





Salvarramas

Longitud Length Longueur	100 cm
Material Material Matière	Poliéster Polyester Polyester
Carga de rotura Breakage load Résistance à la rupture	23 kN
Norm	EN 795



- **Cinta de anclaje salvarramas para hacer anclajes en ramas de árboles o en trabajos verticales.**
Saver anchor tape to make anchors in tree branches or in vertical works.
Bande d'ancrage économiseur pour faire des ancrages dans les branches d'arbres ou dans les travaux verticaux

- **Aros de diferente diámetro que permiten una fácil instalación y una cómoda extracción del punto de anclaje.**
Rings of different diameter that allow an easy installation and a comfortable extraction of the anchor point.
Anneaux de différents diamètres qui permettent une installation facile et une extraction confortable du point d'ancrage.



Cinta motosierra

Longitud Length Longueur	120 cm
Longitud extendida Extended length Longueur prolongée	183 cm
Material Material Matière	Poliéster Polyester Polyester
Carga máxima Breakage load Résistance à la rupture	15 kg

- **Diseñada especialmente para anclar la motosierra durante el trabajo.**
Aro metálico de suspensión de descanso.
Cinta elástica de prolongación.
Specially designed to anchor the chainsaw during work.
Rest suspension metal ring.
Elastic extension tape.
Spécialement conçu pour ancrer la tronçonneuse pendant le travail.
Anneau métallique de suspension de repos.
Bande d'extension élastique.



Portaherramientas

Longitud Length Longueur	93 cm
Longitud extendida Extended length Longueur prolongée	118 cm
Material Material Matière	Poliéster Polyester Polyester
Carga máxima Breakage load Résistance à la rupture	4 kg

- **Evita la caída por manipulación de una herramienta en caso de incidencia.**
Avoid falling due to manipulation of a tool in the event of an incident.
Évitez les chutes dues à la manipulation d'un outil en cas d'incident.



Protector cuerda

Longitud Length Longueur	60 cm
Material Material Matière	PVC PVC PVC
Diámetro Diameter Diamètre	Cuerda de 11 mm 11 mm rope Corde de 11 mm

- **Diseñado para proteger en todos los casos en los que una cuerda sufra o pueda sufrir un roce leve o moderado que la deteriore.**
Designed to protect in all cases in which a rope suffers or may suffer a slight or moderate friction that deteriorates it.
Conçu pour protéger dans tous les cas où une corde subit ou peut subir un frottement léger ou modéré qui la détériore.

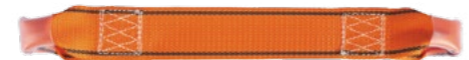

Extensión dorsal

Longitud Length Longueur	40 cm
Material Material Matière	Poliéster Polyester Polyester
Carga de rotura Breakage load Résistance à la rupture	22 kN
Norm	EN 354



» PETATES Y MOCHILAS | CARRY BAGS AND BACKPACKS | SACS POLOCHONS ET SACS À DOS



Petate 5L

	5L
	PVC
	Cordino

- **Amplia y reforzada abertura con anillo interior para una óptima manipulación.**
Wide and reinforced opening with inner ring for optimum internal manipulation.
Ouverture large et renforcée avec bague intérieure pour une manipulation optimale.



Petate 30L

	30L
	PVC
	Velcro
	Cordino

- **Petate en tubo sin cremalleras**
Tube-shaped bag without zippers.
Sac en tube sans fermeture éclair.



Petate 35L

	35L
	PVC
	Asas de pecho Chest straps Sangles de poitrine
	Lumbar regulable Adjustable lumbar Lombaire réglable

- **Petate de transporte para material de protección laboral.**
Carry bag suitable for PPE carriage.
Sac de transport pour matière de protection du travail.

Candanchú

	20L
	PU
	Acolchado hombros Shoulder padded Épaule matelassées
	Termoselladas Thermoselled Thermosoudés

- **Mochila multifuncional en tejido de tela de alta resistencia.**
Multifunctional backpack made of high resistant fabric.
Sac à dos multifonctionnel en tissu très résistant.



Petate Labor

	30L
	TPU
	Válvula aire llenado/ vacío Air valve filled / empty Vanne à air rempli / vide
	Estanca Waterproof Étanche
	Acolchado hombros + espalda Shoulder + back padded Épaule et dos matelassées
	Termoselladas Thermoselled Thermosoudés



- **Petate de transporte para material de protección laboral, 100% estanco.**
Carry bag suitable for PPE carriage, 100% watertight.
Sac de transport pour matière de protection du travail, 100% étanche.



» **PETATES Y MOCHILAS** | CARRY BAGS AND BACKPACKS | SACS POLOCHONS ET SACS À DOS



Bolsa transporte

	20L
	PVC
	Asas laterales frontales Side frontal handles Poignées latérales avant
	Estanca Waterproof Étanche
	Cierre plegable Folding clasp Boucle déployante
	Hebillas Buckles Boucles

● Bolsa tipo bandolera ideal para guardar los sistemas anticaídas.
Shoulder bag suitable for storing the fall arrest products.
Sac à bandoulière idéal pour ranger les systèmes antichute.

PCXRoute

	90L
	PVC
	Compartimentos interiores Interior compartments Compartiments intérieurs
	Asas laterales frontales Side frontal handles Poignées latérales avant
	Rozaduras - Abrasiones Chafing - Abrasions Rayures - Abrasions
	Acolchado hombros Shoulder padded Épaule matelassées

● Petate clásico de alta capacidad para viajes y expediciones.
Classic high capacity backpack for trips and expeditions.
Sac classique de grande capacité pour les voyages et les expéditions.

» **SUMINISTRO Y MONTAJE DE LINEAS DE VIDA PERMANENTE**

| SUPPLY AND ASSEMBLY OF PERMANENT LIFELINES | FOURNITURE ET ASSEMBLAGE DE LIGNES DE VIE PERMANENT

Productos Climax pone a disposición de sus clientes el servicio de Suministro, Instalación y Mantenimiento de Líneas de Vida Permanente. Todos nuestros productos están Certificados y Homologados según Normativa Europea y ofrecen un nivel máximo de calidad. En caso de estar interesados, pueden contactar con nuestro departamento técnico el cual les ofrecerá información detallada del producto que mejor encaje en el ámbito a proteger.

P.Climax offers to our customers the Fourniture, installation and maintenance of permanent Life lines. All our products are Certified and Homologated according per CE regulations, and guarantee a maximum level of quality. Our technical dptm. will provide you a most detailed information according to your needs.

P.Climax offre à ses clients la fourniture, l'assemblage et l'entretien des lignes de vie permanentes. Tous nos produits ont la Certification et approbation d'accord à la réglementation européenne, et offrent le plus haut niveau de qualité. Notre bureau technique vous rendra toute l'information détaillée du produit le plus approprié à vos besoins.





» **COMBINACIONES DE EQUIPAMIENTO**

| EQUIPMENT COMBINATION | COMBINAISONS D'EQUIPEMENT

Kit Arnés

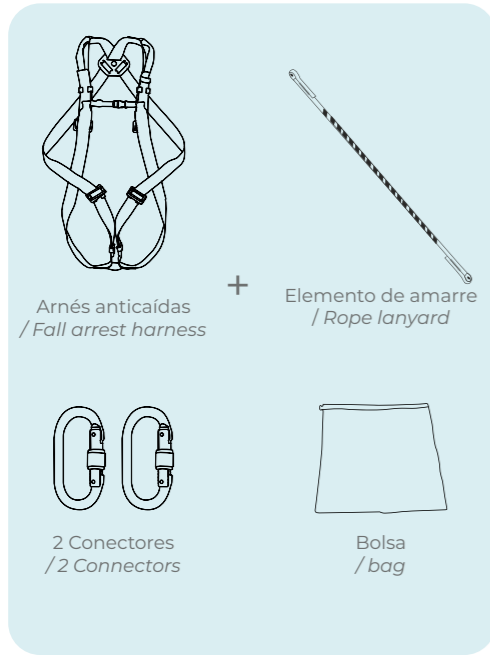

Conjunto

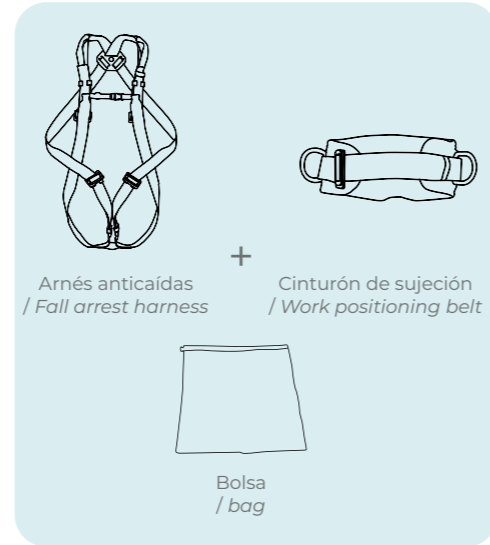

Kit anticaídas

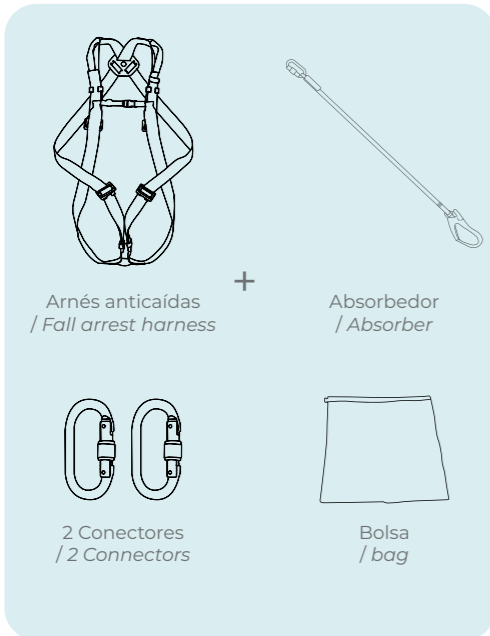

Equipo anticaídas completo

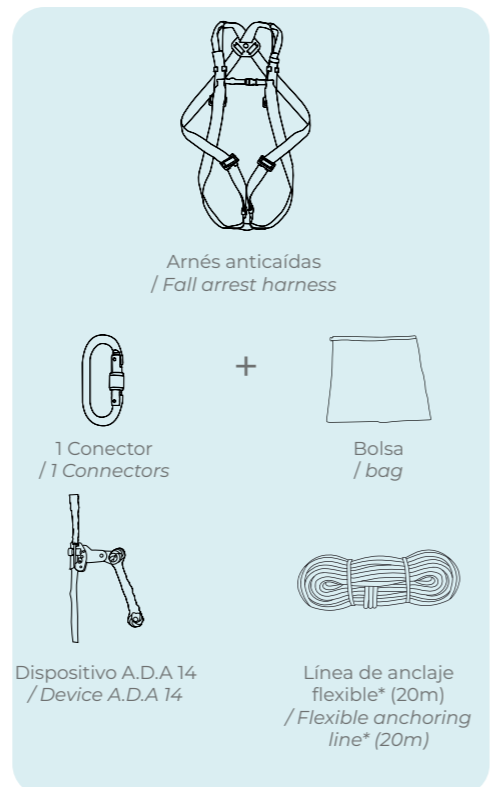



PROTECCIÓN DE LA CABEZA

HEAD PROTECTION

PROTECTION DE LA TÊTE



» **INFOGRAFÍA DE CASCOS** | HELMETS INFOGRAPHY | CASQUES INFOGRAPHIQUE

EN 397:2012+A1:2012

CASCO DE PROTECCIÓN PARA INDUSTRIA
| INDUSTRIAL SAFETY HELMETS | CASQUES DE PROTECTION POUR L'INDUSTRIE

Los cascos de protección para la industria están previstos, fundamentalmente, para proporcionar protección al usuario contra objetos que pudieran caer y las lesiones del cerebro y fracturas de cráneo consiguientes.

Basically, industrial safety helmets are to provide user protection against falling objects and resulting brain injuries and skull fractures.

Les casques de protection pour l'industrie sont fondamentalement prévus pour apporter une protection à l'utilisateur contre des objets pouvant tomber, contre les lésions du cerveau et les fractures du crâne pouvant en découler.

EN 812:2012

CASCOS CONTRA GOLPES PARA LA INDUSTRIA | INDUSTRIAL BUMP CAPS | CASQUETTES ANTI-HEURT POUR L'INDUSTRIE

Los cascos de protección contra choques están destinados a proteger la cabeza del usuario cuando choca con objetos duros e inmóviles que pueden aturdir o causar laceraciones u otras lesiones superficiales. No están destinados a proteger de los efectos derivados de la caída o proyección de objetos ni de cargas suspendidas o en movimiento.

Bump caps to protect the user's head in the case of bangs against hard and stationary objects which may stun or cause lacerations or other superficial injuries. They are not intended to protect against the effects deriving from falling or projected objects or from suspended or moving loads.

Les casquettes de protection antichocs sont destinées à protéger la tête de l'utilisateur lorsqu'il heurte des objets durs et immobiles pouvant assommer ou causer des lacérations ou autres lésions superficielles. Elles ne sont pas destinées à protéger des effets qui dérivent de la chute ou de la projection d'objets ni de charges suspendues ou en mouvement.

EN 12492:2000/A1:2002

CASCOS PARA MONTAÑEROS | HELMETS FOR MOUNTAINEERS | CASQUES D'ALPINISTES

Protector de cabeza destinado a proteger la cabeza de quien lo lleva frente a riesgos que pueden darse en el curso de las actividades realizadas por los escaladores.

Head protection intended to protect the wearer's head against the risks which may arise while performing activities pertaining to climbers.

Protecteur de tête destiné à protéger la tête de celui qui le porte face à des risques susceptibles d'avoir lieu au cours d'activités réalisées par les escaladeurs.

EN 50365:2002

CASCOS ELÉCTRICAMENTE AISLANTES PARA SU UTILIZACIÓN EN BAJA TENSIÓN ||
ELECTRICALLY INSULATING HELMETS FOR USE ON LOW VOLTAGE INSTALLATIONS | CASQUES ÉLECTRIQUEMENT ISOLANTS POUR UTILISATION SUR INSTALLATIONS À BASSE TENSION

Cascos destinados a ser utilizados en trabajos en tensión o en proximidad de partes en tensión sobre instalaciones que no excedan de 1000 V en c.a. o de 1500 V en c.c. Cuando son utilizados simultáneamente con otros equipos de protección eléctricamente aislantes, previenen del paso de una corriente peligrosa a través del usuario entrando por la cabeza.

Helmets to be used when working live or close to live parts in installations not exceeding 1000 VAC or 1500 VDC. They prevent the passage of hazardous currents through the user, entering via the head, when used simultaneously with other electrically insulating protection equipment.

Casques dont l'utilisation est destinée à des travaux en tension ou à proximité d'éléments en tension sur des installations ne dépassant pas 1000 V en c.a. ou 1500 V en c.c. . Lorsqu'ils sont utilisés en même temps que d'autres équipements de protection électriquement isolants, ils préviennent du passage d'un courant dangereux à travers l'utilisateur entrant par la tête.

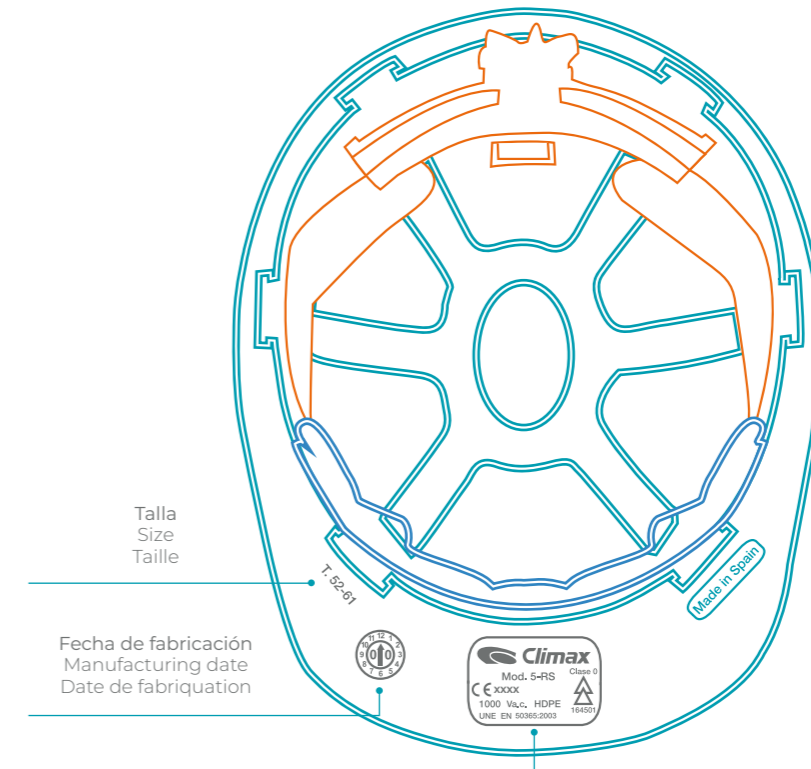

Fabricante
Manufacturer
Fabriquant

Mod. 5-RS
Modelo
Model
Modèle

Clase 0
Normativa
Regulation
Réglementation

Protección casco aislante 1000 Va.c.
Helmet protection insulating 1000 Va.c
Protection casque isolant 1000Va.c

1000 Va.c. HDPE
UNE EN 50365:2003

214501

Símbolo de conformidad con la norma europea / Número de control
Sign of accordance with European standard / control number
Symbole de conformité avec la réglementation européenne / numéro de contrôle.

- 1 **Arnés / Harness / Harnais**
Conjunto completo de elementos que constituyen un medio (a) de mantener el casco en posición sobre la cabeza, y/o (b) de absorber la energía cinética durante el impacto.
Complete set that (a) keeps the helmet in position over the head, and / or (b) of absorbs kinetic energy during impact.
Set d'éléments constituant un moyen (a) de tenir le casque en position sur la tête, et/ou absorber l'énergie pendant l'impact.
- 2 **Banda de nuca ajustable.**
Adjustable banda neck.
Bande de nuque réglable.
- 3 **Banda de cabeza / Head band / Bande de tête**
Parte del arnés que rodea total o parcialmente la cabeza por encima de los ojos.
Harness pat surrounding all or part of head above the eyes.
Partie du harnais entourant entièrement ou partiellement la tête au-dessus des yeux.
- 4 **Banda antisudor / Sweatband / Bandeau de transpiration**
Accesorio que cubre, al menos, la superficie frontal interior de la banda de cabeza para mejorar el confort del usuario
Accessory that covers the inner front surface of the headband to improve user comfort.
Accessoire qui recouvre au moins la surface avant intérieure de la bande de tête pour améliorer le confort de l'utilisateur.

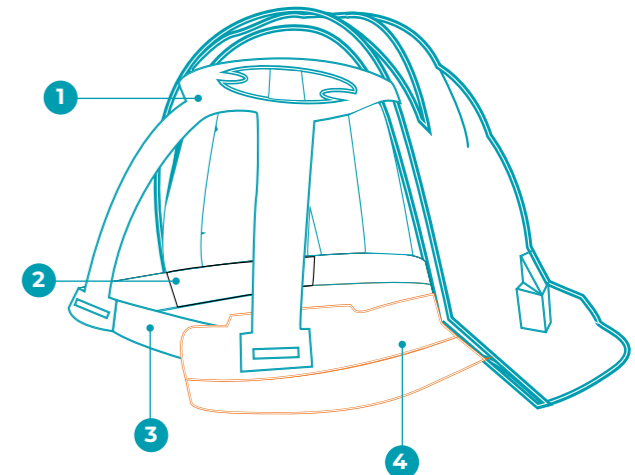

» CASCOS | HELMETS | CASQUES



Curro

Material Material Matière	ABS
Arnés de cabeza Head harness Harnais de tête	Ajuste mediante rueda dentada Automatic adjustment Réglage automatique
Puntos de anclaje Points harness Points d'ancrage	6 textiles
Colores disponibles Available colours Couleurs disponibles	FLUOR
Peso Weight Poids	320 gr
Norm	EN 397 EN 50365

Disponibile con Barboquejo
Available with Chinstrap
Disponible avec Jugulaire

Atalaje textil
Textile harness
Harnais textile

Disponibile con adhesivo reflectante de alta visibilidad
Available with high visibility reflective sticker
Disponible avec un autocollant réfléchissant haute visibilité



Cadí

Material Material Matière	ABS
Arnés de cabeza Head harness Harnais de tête	EPS de alta densidad High density polystyrene EPS de haute densité
Barboquejo Chinstrap Jugulaire	4 puntos 4 points 4 points
Colores disponibles Available colours Couleurs disponibles	FLUOR
Norm	EN 397* EN 12492

Orificios de ventilación
Aeration holes
Orifices de ventilation

Clip de soporte para lámpara
Lamp holder clip
Clip de support pour lampe

Barboquejo
Chinstrap
Jugulaire

EPS Liner



Banda de cabeza ajustable mediante rueda dentada
Adjustable head band with a toothed wheel
Bandeau de tête réglable au moyen d'une roue dentée

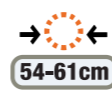

5-RS

Material Material Matière	HDPE
Arnés de cabeza Head harness Harnais de tête	Ajuste manual Manual adjustment Réglage manuel
Protección eléctrica Electrical protection Protection électrique	Hasta 1000V en AC y 1500V en DC (BT) Up to 1000V AC and 1500V DC (low voltage installations) Jusqu'à 1000V en AC et 1500V en DC (BT)
Puntos de anclaje Points harness Points d'ancrage	6
Colores disponibles Available colours Couleurs disponibles	
Peso Weight Poids	325 gr
Norm	EN 397 EN 50365



Ajuste mediante brida
Adjustment by flange
Réglable à bride



Banda antisudor
Sweatband
Bandeau de transpiration



5-RG

Material Material Matière	HDPE
Arnés de cabeza Head harness Harnais de tête	Ajuste mediante rueda dentada Automatic adjustment Réglage automatique
Protección eléctrica Electrical protection Protection électrique	Hasta 1000V en AC y 1500V en DC (BT) Up to 1000V AC and 1500V DC (low voltage installations) Jusqu'à 1000V en AC et 1500V en DC (BT)
Puntos de anclaje Points harness Points d'ancrage	6
Colores disponibles Available colours Couleurs disponibles	
Peso Weight Poids	322 gr
Norm	EN 397 EN 50365



Punto de anclaje
Point harness
Point d'ancrage



30mm
Ranura universal
Helmet slot
Rainure universelle

Atalaje basculante
Folding head harness
Harnais basculant



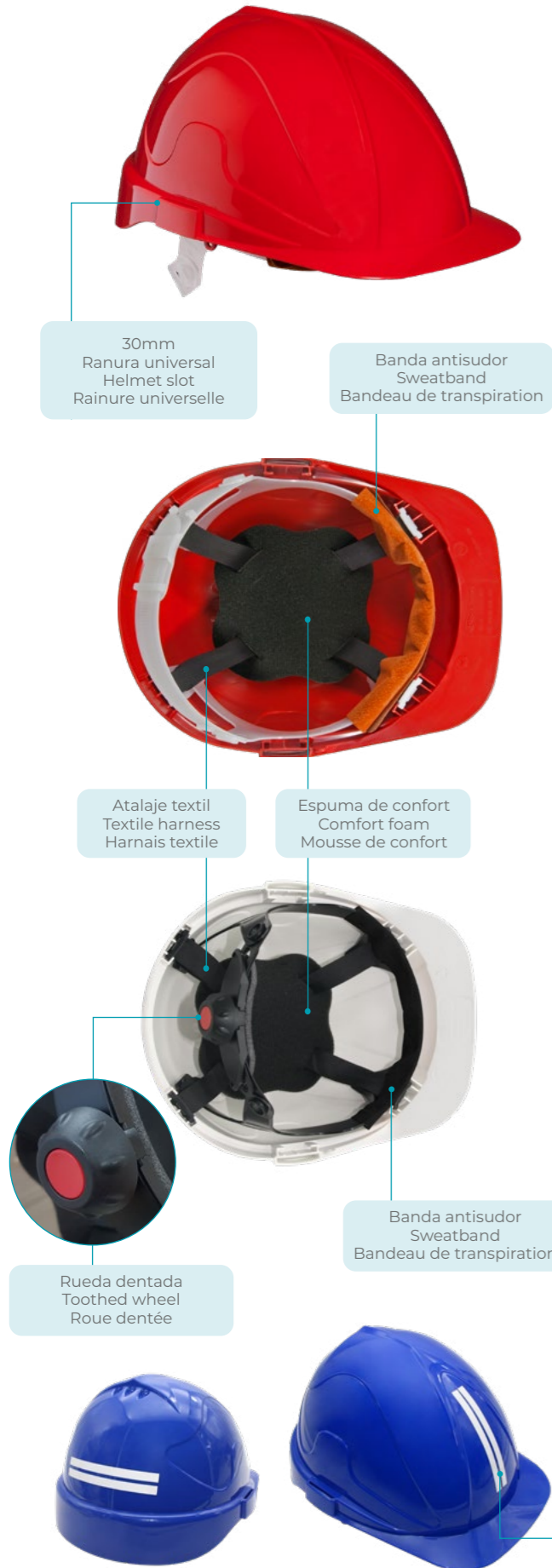

Tirreno TX

Material Material Matière	ABS	
Arnés de cabeza Head harness Harnais de tête	Ajuste manual Manual adjustment Réglage manuel	
Protección eléctrica Electrical protection Protection électrique	Hasta 440V en AC Up to 440V AC Jusqu'à 440V en AC	
Puntos de anclaje Points harness Points d'ancrage	4 (estándar / standard / standard) 6 (bajo demanda / on demand / sur demande)	
Colores disponibles Available colours Couleurs disponibles		
Peso Weight Poids	315 gr	
Norm	EN 397	



Tirreno TXR

Material Material Matière	ABS	
Arnés de cabeza Head harness Harnais de tête	Ajuste automático Automatic adjustment Réglage automatique	
Protección eléctrica Electrical protection Protection électrique	Hasta 440V en AC Up to 440V AC Jusqu'à 440V en AC	
Puntos de anclaje Points harness Points d'ancrage	4 (estándar / standard / standard) 6 (bajo demanda / on demand / sur demande)	
Colores disponibles Available colours Couleurs disponibles		
Peso Weight Poids	355 gr	
Norm	EN 397	



Disponible con adhesivo reflectante de alta visibilidad
Available with high visibility reflective sticker
Disponible avec un autocollant réfléchissant haute visibilité

5-R Minero

Material Material Matière	HDPE	
Arnés de cabeza Head harness Harnais de tête	Ajuste manual Manual adjustment Réglage manuel	Ajuste mediante rueda dentada Automatic adjustment Réglage automatique
Protección eléctrica Electrical protection Protection électrique	Hasta 1000V en AC y 1500V en DC (BT) Up to 1000V AC and 1500V DC (low voltage installations) Jusqu'à 1000V en AC et 1500V en DC (BT)	
Colores disponibles Available colours Couleurs disponibles		
Peso Weight Poids	330 gr	
Norm	EN 397 EN 50365	



» ACCESORIOS | ACCESORIES | ACCESOIRES



Atalaje Curro

Material Material Matière	PES Alta tenacidad PES High tenacity PES Haute ténacité
--	--



Atalaje 5-RS

Material Material Matière	LDPE
--	-------------



Atalaje 5-RG

Material Material Matière	LDPE
--	-------------



Atalaje TX

Material Material Matière	PES Alta tenacidad PES High tenacity PES Haute ténacité
--	--



Atalaje TXR

Material Material Matière	PES Alta tenacidad PES High tenacity PES Haute ténacité
--	--



Barboquejo 5-RSY

Accesorio de los cascos Accesorio de los cascos Accesorio de los cascos	5-RS 5-RG Curro 5-R Minero
--	---



Barboquejo Chin strap / Juglaire

Accesorio de los cascos
| Accessorio de los cascos |
Accesorio de los cascos

5-RS
5-RG
Tirreno TX
Tirreno TXR



Barboquejo con mentonera Chin strap with chin rest Jugulaire avec mentonniè

Accesorio de los cascos
| Accessorio de los cascos |
Accesorio de los cascos

5-RS
5-RG
Tirreno TX
Tirreno TXR



Perfil con regulador para pantallas / Face shield holder der / Profil avec réglateur

Accesorio de los cascos
| Accessorio de los cascos |
Accesorio de los cascos

Cadí
5-RS
5-RG
Tirreno TX
Tirreno TXR



Anclaje Adaptor / Jeu d'ancrage

Accesorio de los cascos
| Accessorio de los cascos |
Accesorio de los cascos

Cadí
5-RS
5-RG
Tirreno TX
Tirreno TXR



Banda antisudor / Sweat- band / Bandeau de transpiration

Accesorio de los cascos
| Accessorio de los cascos |
Accesorio de los cascos

5-RS

Material
| Material |
Matière

Flock de rayón
Viscose rayon flock
Flock de rayonne



Banda antisudor / Sweat- band / Bandeau de transpiration

Versiones
| Versions |
Versions

Marrón
Brown
Marron

Negro
Black
Noir

Accesorio de los cascos
| Accessorio de los cascos |
Accesorio de los cascos

Curro
5-RG
Tirreno TX
Tirreno TXR

Material
| Material |
Matière

Flock de rayón
Viscose rayon flock
Flock de rayonne



» GORRAS | SHOCKPROOF CAPS | CHAPEAUX



GA

Banda reflectante
Reflective Band
Bande réfléchissante

Gorra antigolpes
Bump cap
Casquette antichocs

Material Material Matière	Poliamida, PE Polyamide, PE Polyamide, PE
Talla Size Taille	→ ← 54-59cm
Medidas visera Visor measures Mesures visière	78 x 160 cm
Norm	EN 812



GR

Banda reflectante
Reflective Band
Bande réfléchissante



GN

Banda reflectante
Reflective Band
Bande réfléchissante



GB

Ajuste de velcro
Adjustment with velcro
Ajustement avec velcro



Casquete plástico de ABS con almohadillas soft interna y externa para absorción de golpes.

ABS plastic shell with soft internal and external padding for shock absorption.

Manchon en plastique ABS avec coussinets soft intérieur et extérieur pour absorber les coups.

Linterna frontal Compact

Headlamp compact
Lampe frontale compacte

Resistencia al agua Water resistance Résistance à l'eau	IPX6
Potencia Potency Puissance	180 lm
Peso Weight Poids	160 g

Banda elástica desmontable y lavable.

Removable and washable elastic band.
Bande élastique amovible et lavable.

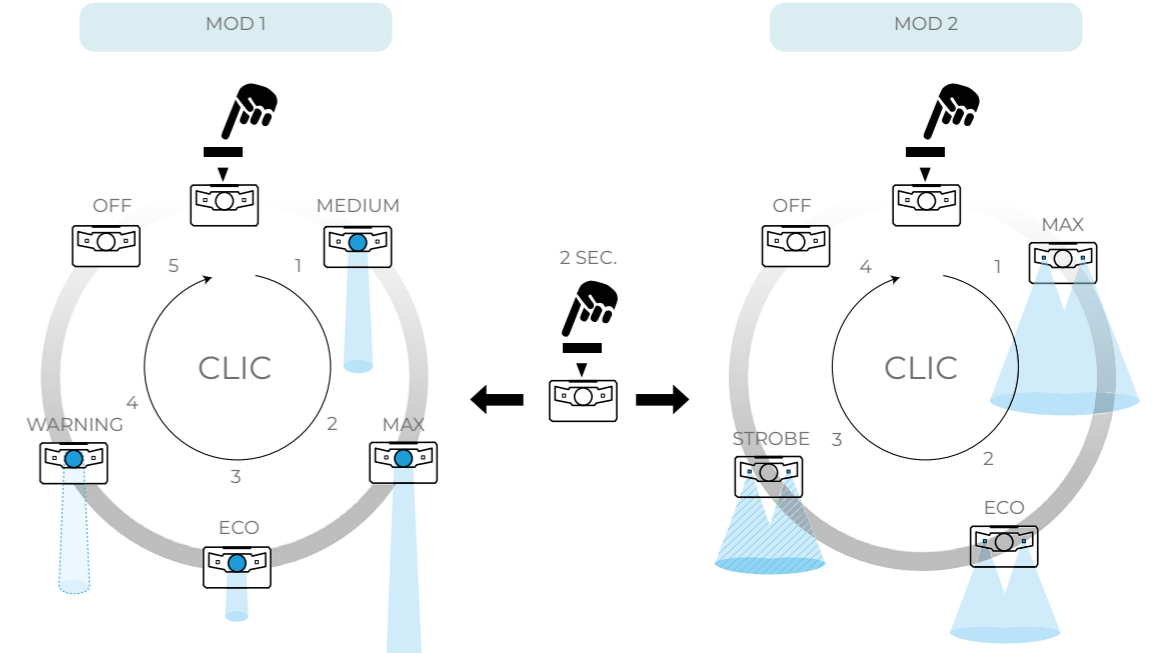
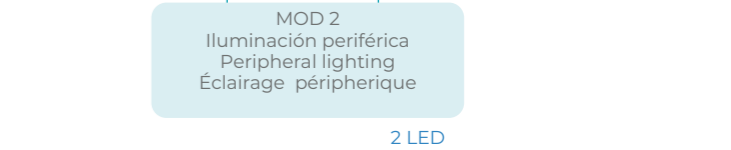
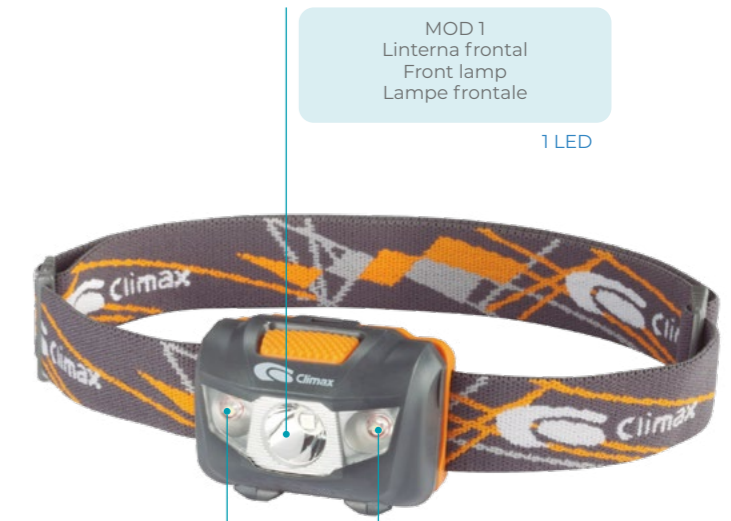

NIVELES
LEVELS
NIVEAUX



Tres niveles de iluminación
Three lighting levels
Trois niveaux d'éclairage



PROTECCIÓN FACIAL Y OCULAR

FACE AND EYE PROTECTION
PROTECTION DES YEUX ET DU
VISAGE

» PANTALLAS FACIALES CON CASCO
| FACE SHIELDS WITH HELMET | ÉCRANS FACIAUX AVEC CASQUE





PROTECCIÓN FRENTE A ARCO ELÉCTRICO.
PROTECTION AGAINST ELECTRIC ARC.
PROTECTION CONTRE L'ARC ÉLECTRIQUE.

436D	
 	Casco Helmet Casque
Material Material Matière	HDPE
Talla atalaje Harness size Taille du harnais	→ ← 54-61cm
Mentonera Chin strap Mentonnière	PEHD
Colores disponibles Available colours Couleurs disponibles	
Visor Visor Visière	
Material Material Matière	Policarbonato amarillo con tratamiento anti vaho. Yellow polycarbonate with anti-fog treatment. Polycarbonate jaune avec traitement antibuée.
Medidas Size Dimensions	185 x 500 x 1,5 (mm)
Marcado Marking Marquage	2C-1.4 PMC 1 B 8-2-1 3 C € 1883
Norm	ANSI Z87 & GS-ET-29, Class 2 EN 166 & 170:2002 EN 397 EN 50365





PROTECCIÓN FRENTE A ARCO ELÉCTRICO.
PROTECTION AGAINST ELECTRIC ARC.
PROTECTION CONTRE L'ARC ÉLECTRIQUE.

436DV	
 	Casco Helmet Casque
Material Material Matière	HDPE
Talla atalaje Harness size Taille du harnais	→ ← 54-61cm
Colores disponibles Available colours Couleurs disponibles	
Visor Visor Visière	
Material Material Matière	Policarbonato incoloro Clear polycarbonate Polycarbonate incolore
Medidas Size Dimensions	200 x 390 x 1,5 (mm)
Marcado Marking Marquage	2C-1.2 Climax 1 B 8-1-0 9 C € 0161
Norm	EN 166:2002 EN 170 EN 50365 GS-ET-29, Class 1 (135 kJ/m2)



436 Incoloro	
 	Casco Helmet Casque
Material Material Matière	HDPE
Talla atalaje Harness size Taille du harnais	→ ← 54-61cm
Colores disponibles Available colours Couleurs disponibles	
Visor Visor Visière	
Material Material Matière	Policarbonato incoloro Clear polycarbonate Polycarbonate incolore
Medidas Size Dimensions	389 x 201 x 1,5 (mm)
Marcado Marking Marquage	2C-1.2 Climax 1 B 3 C €
Norm	EN 166 EN 397 EN 50365



436 Verde	
 	Casco Helmet Casque
Material Material Matière	HDPE
Talla atalaje Harness size Taille du harnais	→ ← 54-61cm
Colores disponibles Available colours Couleurs disponibles	
Visor Visor Visière	
Material Material Matière	Policarbonato verde Green polycarbonate Polycarbonate vert
Medidas Size Dimensions	389 x 201 x 1,5 (mm)
Marcado Marking Marquage	5 Climax 1 B C €
Norm	EN 166 EN 169 EN 175 EN 50365





436 Malla	
<p>Casco Helmet Casque</p>	
Material Material Matière	HDPE
Talla atalaje Harness size Taille du harnais	→ ← 54-61cm
Colores disponibles Available colours Couleurs disponibles	
Visor Visor Visière	
Material Material Matière	Malla de hierro pintada con epoxy negro Iron mesh painted with black epoxy paint Maille en fer peinte à époxy noire
Medidas Size Dimensions	380 x 208 x 0,3 (mm)
Marcado Marking Marquage	Climax EN 1731 S C€
Norm	EN 397 EN 1731 EN 50365



437-I Complet	
<p>Casco Helmet Casque</p>	
Material Material Matière	HDPE + Protector de oído 17-P HDPE + Ear muff 17-P HDPE + Protecteur auditif 17-P
Talla atalaje Harness size Taille du harnais	→ ← 54-61cm
Colores disponibles Available colours Couleurs disponibles	
Visor Visor Visière	
Material Material Matière	Polycarbonato incoloro Clear polycarbonate Polycarbonate incolore
Medidas Size Dimensions	389 x 201 x 1,5 (mm)
Marcado Marking Marquage	2C-1.2 Climax 1 B 3 C€
Norm	EN 352-3 EN 397 EN 1731 EN 50365



437 Complet	
<p>Casco Helmet Casque</p>	
Material Material Matière	HDPE + Protector de oído 17-P HDPE + Ear muff 17-P HDPE + Protecteur auditif 17-P
Talla atalaje Harness size Taille du harnais	→ ← 54-61cm
Colores disponibles Available colours Couleurs disponibles	
Visor Visor Visière	
Material Material Matière	Malla de hierro pintada con epoxy negro Iron mesh painted with black epoxy paint Maille en fer peinte à époxy noire
Medidas Size Dimensions	380 x 208 x 0,3 (mm)
Marcado Marking Marquage	Climax EN 1731 S C€
Norm	EN 352-3 EN 397 EN 1731 EN 50365



Climax 10 Forestal

Casco Helmet Casque	
Material Material Matière	HDPE + Protector de oído Climax 10 HDPE + Ear muff Climax 10 HDPE + Protecteur auditif Climax 10
Talla atalaje Harness size Taille du harnais	→ ← 52-61cm
Visor Visor Visière	
Material Material Matière	Malla de hierro pintada con epoxy negro Iron mesh painted with black epoxy paint Maille en fer peinte à époxy noire
Medidas Size Dimensions	380 x 208 x 0,3 (mm)
Marcado Marking Marquage	Climax EN 1731 S C€
Norm	EN 352-1 EN 1731



» PANTALLAS FACIALES | FACE SHIELDS | ÉCRANS FACIAUX



324-RG

Casco | Helmet | Casque

Material Material Matière	HDPE
Talla atalaje Harness size Taille du harnais	→ ← 52-61cm
Visor Visor Visière	
Material Material Matière	Policarbonato incoloro Clear polycarbonate Polycarbonate incolore
Medidas Size Dimensions	389 x 201 x 1,5 (mm)
Marcado Marking Marquage	2C-1.2 Climax 1 B 3 C €
Norm	EN 166 EN 170



324-RG/N (Antivaho)

Casco | Helmet | Casque

Material Material Matière	HDPE
Talla atalaje Harness size Taille du harnais	→ ← 52-61cm
Visor Visor Visière	
Material Material Matière	Policarbonato incoloro Clear polycarbonate Polycarbonate incolore
Medidas Size Dimensions	389 x 201 x 1,5 (mm)
Marcado Marking Marquage	2C-1.2 Climax 1 B 3 N C €
Norm	EN 166 EN 170



325

Casco | Helmet | Casque

Material Material Matière	ABS
Talla atalaje Harness size Taille du harnais	→ ← 57-62cm
Visor Visor Visière	
Material Material Matière	Policarbonato incoloro Clear polycarbonate Polycarbonate incolore
Medidas Size Dimensions	300 x 200 x 0,4 (mm)
Marcado Marking Marquage	Rfu 03.031/V1 Climax-1-3
Norm	Rfu 03.031/V1



425

Casco | Helmet | Casque

Material Material Matière	HDPE
Talla atalaje Harness size Taille du harnais	→ ← 52-61cm
Visor Visor Visière	
Material Material Matière	Malla de hierro pintada con epoxy negro Iron mesh painted with black epoxy paint Maille en fer peinte à époxy noire
Medidas Size Dimensions	380 x 208 x 0,3 (mm)
Marcado Marking Marquage	Climax EN 1731 S C €
Norm	EN 1731



» **RECAMBIOS VISORES** | VISORS REPLACEMENT | PIÈCE DÉTACHÉE VISIÈRES



Polycarbonato incoloro
| Clear polycarbonate |
Polycarbonate incolore

324-RG / 324-RG/N / 436-I

Adecuados para aplicaciones en las que se puedan producir salpicaduras de productos químicos (ácidos diluidos, grasas y aceites, alcoholes e hidrocarburos aromáticos). Ofrece protección frente a la radiación UV 2C-1.2. Resistencia al empañamiento 55 seg. (N). Clase óptica 1. Medidas: 389 x 201 x 1,5 (mm)

Appropriate for applications that may lead to chemical product splashes (diluted acids, grease and oils, alcohols and aromatic hydrocarbons). It protects against UV 2C-1.2 radiation. 55 s resistance against steaming up (N). Optical class 1. Measurements: 389 x 201 x 1,5 (mm)

Adaptés aux applications où peuvent se produire des éclaboussures de produits chimiques (acides dilués, graisses et huiles, alcools et hydrocarbures aromatiques). Elles offrent une protection face aux rayons UV 2C-1.2. Résistance à la condensation 55 s. (N), Classe optique 1. Dimensions: 389 x 201 x 1,5 (mm)



Polycarbonato verde
| Green polycarbonate |
Polycarbonate vert

324-RG VERDE

Adecuados para la protección contra las radiaciones emitidas en los procesos de soldadura oxiacetilénica y de oxicorte y contra el impacto de partículas. Grado de protección 5 (EN 169). Clase óptica 1. Medidas: 389 x 201 x 1,5 (mm)

Appropriate for protection against radiations given off in oxyacetylene welding and oxycutting processes and against particle impacts. Protection level 5 (EN 169). Optical class 1. Measurements: 389 x 201 x 1,5 (mm)

Adaptés à la protection contre les radiations émises lors des processus de soudure oxyacétylénique et oxycoupage ainsi que contre l'impact de particules. Degré de protection 5 (EN 169). Classe optique 1. Dimensions: 389 x 201 x 1,5 (mm)



Malla metálica
| Metal mesh |
Maille métallique

425 / 436 malla / 437 Complet

Adecuados para la protección contra las partículas generadas en trabajos forestales (astillas, vegetación y partículas). Malla de hierro pintada con pintura epoxy negra. Luz de malla 1.089 mm. Medidas: 380 x 208 x 0,3 (mm)

Appropriate for protection against particles generated in forestry work (splinters, vegetation and particles). Iron mesh painted with black epoxy paint. Mesh size 1,089 mm. Measurements: 380 x 208 x 0,3 (mm)

Adaptés à la protection contre les particules générées lors des travaux forestiers (éclats de bois, végétation y particules). Maille en fer peinte à la peinture époxy noire. Tamis de la maille 1.089 mm. Dimensions: 380 x 208 x 0,3 (mm)



» **GAFAS DE PROTECCIÓN** | SAFETY SPECTACLES | LUNETTES DE PROTECTION

Azahara

Versiónes Versions Versions	Incolora Colorless Incolores	Incolora NK NK Colorless Incolores NK	Amarilla Yellow Jaune	Humo Smoke Fumée
Marcado del ocular Lens markings Marquage des oculaires	2C-1.2 Climax	2C-1.2 Climax	2C-1.2 Climax	5-3.1 Climax
Material montura Frame material Matière du cadre	Vinilo Vinyl Vinyle			
Material lente Lense material Matière visière	PC PC PC			
Tratamiento Treatment Traitement	Anti vaho / Anti ralladuras Anti fog / Anti scratches Anti-buée / Anti-rayures			
Norm	EN 166 EN 170	EN 166 EN 170	EN 166 EN 170	EN 166 EN 172



• Mayor tamaño para permitir el uso de gafas de prescripción. It can be used with prescription glasses. Il peut être utilisée avec des lunettes de prescription.

• Ranura lateral que permite un ajuste hermético con las gafas de prescripción. Side groove that allows a hermetic fit with prescription glasses. Rainure latérale qui permet un ajustement étanche avec des lunettes de vue.

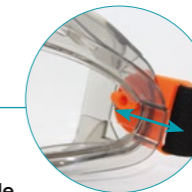

Abierta / Open / Ouvert
Cerrada / Closed / Fermé



La gafa puede ser higienizada mediante un ciclo de autoclave. Soporta 4 ciclos de esterilizado en autoclave a 121 °C, 15 minutos. The goggle can be sanitized by means of an autoclave cycle. Supports 4 cycles of autoclaving at 121 °C, 15 minute. Les verres peuvent être désinfectés par un cycle d'autoclave. Résiste à 4 cycles d'autoclavage à 121°C, 15 minutes.

539

Versiónes Versions Versions	Abierta Open Oubert	Cerrada Closed Fermé
Referencias References Références	539	539 C
Material Material Matière	Vinilo flexible Flexible vinyl frame Vinyle flexible	
Marcado del ocular Lens markings Marquage des oculaires	PCX EN 166 3 F N CE	PCX EN 166 3 4 5 F N CE
Tratamiento Treatment Traitement	Anti-vaho Anti-fog Ventilación cerrada Anti-buée	
Norm	EN 166	



• Mayor tamaño para permitir el uso de gafas de prescripción. It can be used with prescription glasses. Il peut être utilisée avec des lunettes de prescription.

• Clase óptica 1. Optical class 1. Classe optique 1.



539

ABIERTO. Campos de uso:
Líquidos: 3
OPEN. Fields of use: Droplets: 3
OUVERT. Domaine d'utilisation: Liquides: 3



539-C

CERRADO. Campos de uso: Líquidos: 3 / Partículas de polvo gruesas: 4 / Partículas de polvo finas: 5
CLOSED. Fields of use: Droplets: 3 / Resistant to large dust particles: 4 / Resistant to gas and fine dust particles: 5
FERMÉ. Domaine d'utilisation: Liquides: 3 / Particules de poussière épaisses: 4 / Particules de poussière fines: 5



569			
Versiones Versions Versions	Incolora Colorless Incolores	Amarilla Yellow Jaune	Gris Grey Gris
Referencias References Références	569-I	569-A	569-G
Marcado del ocular Lens markings Marquage des oculaires	2C-1.2  Climax 1 F CE	2C-1.2  Climax 1 F CE	5-4.1  Climax 1 F CE
Material Material Matière	Policarbonato Polycarbonate Polycarbonate		
Norm	EN 166 EN 170	EN 166 EN 170	EN 166 EN 172



580			
Versiones Versions Versions	Incolora Colorless Incolores	Amarilla Yellow Jaune	Verde Green Verte
Referencias References Références	580-I	580-A	580-V
Marcado del ocular Lens markings Marquage des oculaires	 Climax 1 F CE	2-1.2  Climax 1 F CE	5-2.5  Climax 1 F CE
Material Material Matière	Policarbonato Polycarbonate Polycarbonate		
Norm	EN 166	EN 166 EN 170	EN 166 EN 172

- **Policarbonato antirrayaduras que aporta resistencia y durabilidad.**
Polycarbonate scratch resistant providing toughness and durability.
Polycarbonate anti-rayures qui apporte résistance et durabilité.

590			
Versiones Versions Versions	Incolora Colorless Incolores	Amarilla Yellow Jaune	Gris Grey Gris
Referencias References Références	590-I	590-A	590-G
Marcado del ocular Lens markings Marquage des oculaires	 Climax 2 F CE	2-1.2  Climax 2 F CE	5-3.1  Climax 2 F CE
Material Material Matière	Policarbonato Polycarbonate Polycarbonate		
Norm	EN 166	EN 166 EN 170	EN 166 EN 172



595			
Versiones Versions Versions	Incolora Colorless Incolores	Amarilla Yellow Jaune	Gris Grey Gris
Referencias References Références	595-I	595-A	595-G
Marcado del ocular Lens markings Marquage des oculaires	2C-1.2  Climax 1 F T CE	2-1.2  Climax 1 F T CE	5-3.1  Climax 1 F T CE
Material Material Matière	Policarbonato Polycarbonate Polycarbonate		
Norm	EN 166 EN 170	EN 166 EN 170	EN 166 EN 172

- **Protección frente a los riesgos de impactos de partículas de alta velocidad y baja energía (F)**
Protection against hazard of impact from high-speed and low energy particles (F).
Protection contre les risques d'impacts de particules à haute vitesse et basse énergie (F).
- **Patillas tipo espátula para un ajuste muy cómodo.**
Spatulatype temples for very comfortable adjustment.
Branches type spatule pour un réglage plus pratique.



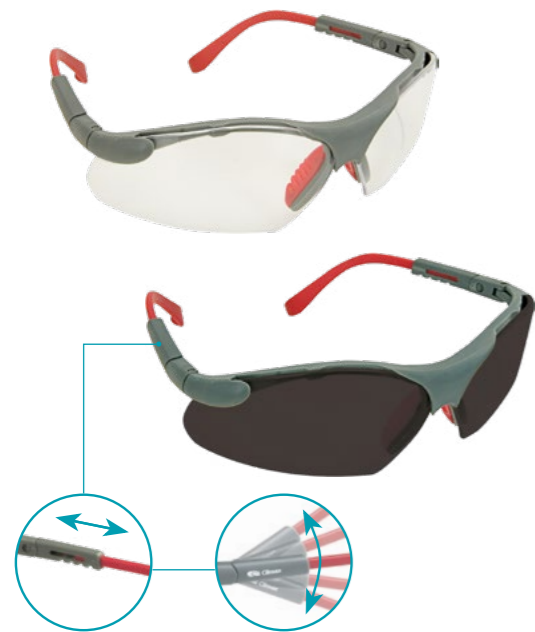

597			
Versiones Versions Versions	Incolora Colorless Incolores	Gris Grey Gris	
Referencias References Références	597-I	597-G	
Marcado del ocular Lens markings Marquage des oculaires	2C-1.2	5-3.1	
	Climax	Climax	
Material Material Matière	Polycarbonato Polycarbonate Polycarbonate		
Norm	EN 166 EN 170	EN 166 EN 172	

- **Puente nasal blando y patillas de longitud ajustable con sistema pantoscópico.**
Soft nose bridge and adjustable length temples with pantoscopic system.
Pont nasal souple et branches de longueur réglable avec système pantoscopique.



598			
Versiones Versions Versions	Incolora Colorless Incolores	Gris Grey Gris	Gris polarizada Polarized Grey Gris polarisé
Referencias References Références	598-I	598-G	598-P
Marcado del ocular Lens markings Marquage des oculaires	5-3.1	5-3.1	5-3.1
	Climax	Climax	Climax
Material Material Matière	Polycarbonato Polycarbonate Polycarbonate		
Norm	EN 166	EN 166 EN 172	EN 166 EN 172

599			
Versiones Versions Versions	Incolora Colorless Incolores	Marrón Brown Marron	Gris Grey Gris
Referencias References Références	599-I	599-M	599-G
Marcado del ocular Lens markings Marquage des oculaires	2C-1.2	5-1.7	5-3.1
	Climax	Climax	Climax
Material Material Matière	Polycarbonato Polycarbonate Polycarbonate		
Norm	EN 166 EN 170	EN 166 EN 172	EN 166 EN 172



571	
Versiones Versions Versions	Incolora Colorless Incolores
Marcado del ocular Lens markings Marquage des oculaires	2C-1.2 Climax
Material Material Matière	Polycarbonato Polycarbonate Polycarbonate
Norm	EN 166 EN 170

- **Protectores integrados laterales al igual que protector de cejas.**
Integrated side shields and brow guard.
Protecteurs intégrés latéraux de même que le protecteur de sourcils.
- **Puente universal para fácil ajuste.**
Universal nose bridge for easy adjustment.
Pont universel pour un réglage facile.
- **Clase óptica 1.**
Optical class: 1.
Classe optique 1.



630	
Versiones Versions Versions	Gris Grey Gris
Marcado del ocular Lens markings Marquage des oculaires	5-3.1 Climax
Material Material Matière	Polycarbonato + TPE Polycarbonate + TPE Polycarbonate + TPE
Norm	EN 166 EN 172



PROTECCIÓN EN SOLDADURA
WELDING PROTECTION
PROTECTION SOUDURE

» PANTALLA DE SOLDADURA DE CABEZA | WELDING FACE SHIELDS | MASQUES DE TÊTE



420	
Dimensiones armazón Helmet shell size Dimensions structure	325 x 235 mm
Material Material Matière	Poliamida Polyamide Polyamide
Tonos Shades Nuances	Claro 4 y activado variable 9 al 13 Clear 4 and variable 9-13 Clair 4 et activation variable de 9 à 13
Alimentación Power supply Alimentation	Células solares y pila (no recambiable) Solar cells and battery (not replaceable) Cellules solaires et pile (non remplaçable)
Talla atalaje Harness size Taille du harnais	52-61cm
Norm	EN 166 EN 175 EN 379

Aplicaciones / Applications / Application

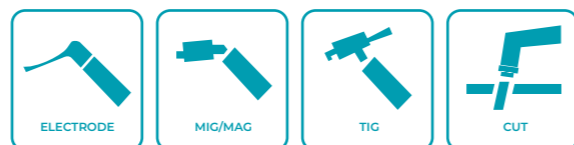

421	
Dimensiones armazón Helmet shell size Dimensions structure	325 x 235 mm
Material Material Matière	Poliamida Polyamide Polyamide
Tonos Shades Nuances	Claro 4 y activado variable 9 al 13 Clear 4 and variable 9-13 Clair 4 et activation variable de 9 à 13
Alimentación Power supply Alimentation	Células solares y baterías Solar cells and batteries Cellules solaires et piles
Talla atalaje Harness size Taille du harnais	52-61cm
Norm	EN 166 EN 175 EN 379

Aplicaciones / Applications / Application

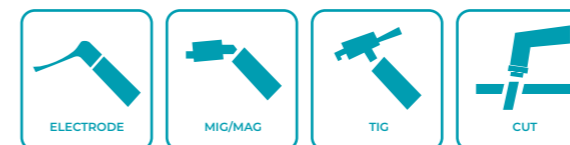

UV/IR protection: Tono 16 (permanente)
UV/IR protection: Shade 16 (permanent)
UV/IR protection: Tonalité 16 (permanent)

Medidas Size Dimensions	110 x 90 x 9 mm
Área de visión Viewing area Zone de visualisation	100 x 41 mm
Detectores de luz Light detectors Détecteurs de lumière	2
Tiempo de reacción Reaction time Temps de réaction	0,2 ms
Clase óptica Optical class Classe optique	1
Difusión de la luz Diffusion of light Diffusion de la lumière	1
Variación del factor de transmisión en el visible Variation of the transmission factor in the visible Variation du facteur de transmission dans le visible	1
Dependencia del factor de transmisión en el visible con el ángulo de incidencia Dependence of the transmission factor in the visible with the angle of incidence Dépendance du facteur de transmission dans le visible avec l'angle d'incidence	2

Conmutador de modos
Switch modes
Changement de mode

Indicador de batería baja
Low Battery Indicator
Indicateur de batterie faible



Pila recambiable
autonomía de 5000h
Replaceable battery
5000h autonomy
Batterie remplaçable
autonomie 5000h

UV/IR protection: Tono 16 (permanente)
UV/IR protection: Shade 16 (permanent)
UV/IR protection: Tonalité 16 (permanent)

Medidas Size Dimensions	110 x 90 x 9 mm
Área de visión Viewing area Zone de visualisation	100 x 45 mm
Detectores de luz Light detectors Détecteurs de lumière	4
Tiempo de reacción Reaction time Temps de réaction	0,2 ms
Clase óptica Optical class Classe optique	1
Difusión de la luz Diffusion of light Diffusion de la lumière	1
Variación del factor de transmisión en el visible Variation of the transmission factor in the visible Variation du facteur de transmission dans le visible	1
Dependencia del factor de transmisión en el visible con el ángulo de incidencia Dependence of the transmission factor in the visible with the angle of incidence Dépendance du facteur de transmission dans le visible avec l'angle d'incidence	2

SENSIBILIDAD: Ajuste de la sensibilidad del arco.
SENSITIVITY: Sensitive knob.
SENSIBILITE: Réglage de la sensibilité de l'arc de l'état foncé à clair.

9-13
POTENCIÓMETRO: Ajuste del tono.
POTENTIOMETER: Shade knob.
POTENTIOMÈTRE: Potentiomètre pour réglage de ton.

1 2 3
RETARDO: Ajuste del tiempo de transición de estado oscuro al claro entre 0,1 a 1 s.
DELAY: It controls the speed at which the filter returns to the light state after between 0,1 to 1 s.
RETARD: Welding has stopped réglage de la sensibilité de l'arc entre 0,1 à 1 s.

SENSIBILIDAD: Ajuste de la sensibilidad del arco.
SENSITIVITY: Sensitive knob.
SENSIBILITE: Réglage de la sensibilité de l'arc de l'état foncé à clair.

9-13
POTENCIÓMETRO: Ajuste del tono.
POTENTIOMETER: Shade knob.
POTENTIOMÈTRE: Potentiomètre pour réglage de ton.

1 2 3
RETARDO: Ajuste del tiempo de transición de estado oscuro al claro entre 0,1 a 1 s.
DELAY: It controls the speed at which the filter returns to the light state after between 0,1 to 1 s.
RETARD: Welding has stopped réglage de la sensibilité de l'arc entre 0,1 à 1 s.



422

Dimensiones armazón Helmet shell size Dimensions structure	325 x 235 mm
Material Material Matière	Poliamida Polyamide Polyamide
Tonos Shades Nuances	Claro 4 y activado variable 9 al 13 Clear 4 and variable 9-13 Clair 4 et activation variable de 9 à 13
Alimentación Power supply Alimentation	Células solares y pila (no recambiable) Solar cells and batterie (not replaceable) Cellules solaires et pile (non remplaçable)
Talla atalaje Harness size Taille du harnais	52-61cm
Norm	EN 166 EN 175 EN 379

Aplicaciones / Applications / Application

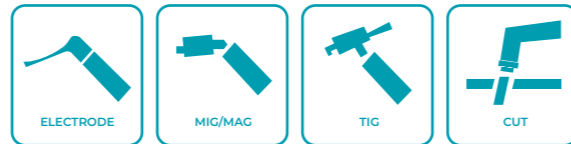

Conmutador de modos
Switch modes
Changement de mode



UV/IR protection: Tono 16 (permanente)
UV/IR protection: Shade 16 (permanent)
UV/IR protection: Tonalité 16 (permanent)

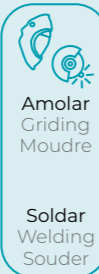

Medidas Size Dimensions	110 x 90 x 9 mm
Área de visión Viewing area Zone de visualisation	92 x 42 mm
Detectores de luz Light detectors DéTECTEURS de lumière	2
Tiempo de reacción Reaction time Temps de réaction	< 0,5 ms
Clase óptica Optical class Classe optique	1
Difusión de la luz Diffusion of light Diffusion de la lumière	1
Variación del factor de transmisión en el visible Variation of the transmission factor in the visible Variation du facteur de transmission dans le visible	1
Dependencia del factor de transmisión en el visible con el ángulo de incidencia Dependence of the transmission factor in the visible with the angle of incidence Dépendance du facteur de transmission dans le visible avec l'angle d'incidence	2



SENSIBILIDAD: Ajuste de la sensibilidad del arco.
SENSITIVITY: Sensitive knob.
SENSIBILITE: Réglage de la sensibilité de l'arc de l'état foncé à clair.

9-13

POTENCIÓMETRO: Ajuste del tono.
POTENTIOMETER: Shade knob.
POTENTIOMÈTRE: Potentiomètre pour réglage de ton.



1 2 3

RETARDO: Ajuste del tiempo de transición de estado oscuro al claro entre 0.1 a 1 s.
DELAY: It controls the speed at which the filter returns to the light state after between 0.1 to 1 s.
RETARD: Welding has stopped réglage de la sensibilité de l'arc entre 0,1 à 1 s.



415-E

Conjunto formado por Set composed of Ensemble formé par	Casco 5-RG / Pantalla 415 5-RG helmet / 415 Welding shield Casque 5-RG / Écran 415
Tonos Shades Nuances	Claro 4 y activado variable 9 al 13 Clear 4 and variable 9-13 Clair 4 et activation variable de 9 à 13
Alimentación Power supply Alimentation	Células solares y baterías Solar cells and batteries Cellules solaires et piles
Talla atalaje Harness size Taille du harnais	52-61cm
Norm	EN 166 EN 397 EN 175 EN 50365 EN 379

Aplicaciones / Applications / Application

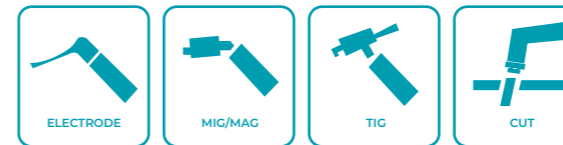

405-C

Material Material Matière	Poliamida Polyamide Polyamide
Medidas del ocular Welding glass measurements Dimension de l'oculaire	110 x 90 mm
Tonos disponibles Available shades Nuances disponibles	9 - 13
Talla atalaje Harness size Taille du harnais	52-61cm
Norm	EN 166 EN 169 EN 175





405-CPA	
Material Material Matière	Polipropileno Polypropylene Polypropylène
Medidas del ocular Welding glass measurements Dimension de l'oculaire	105 x 50 mm 108 x 51 mm 110 x 50 mm 110 x 55 mm 110 x 60 mm
Tonos disponibles Available shades Nuances disponibles	9 - 13
Talla atalaje Harness size Taille du harnais	→ ← 52-61cm
Norm	EN 166 EN 169 EN 175



405-CP	
Material Material Matière	Polipropileno Polypropylene Polypropylène
Medidas del ocular Welding glass measurements Dimension de l'oculaire	105 x 50 mm 108 x 51 mm 110 x 50 mm 110 x 55 mm 110 x 60 mm
Tonos Shades Nuances	9 - 13
Talla atalaje Harness size Taille du harnais	→ ← 52-61cm
Norm	EN 166 EN 169 EN 175



412-R	
Material Material Matière	Fibra vulcanizada Vulcanized fiber Fibre vulcanisée
Medidas del ocular Welding glass measurements Dimension de l'oculaire	105 x 50 mm 110 x 55 mm
Tonos Shades Nuances	9 - 13
Talla atalaje Harness size Taille du harnais	→ ← 52-61cm
Norm	EN 166 EN 169 EN 175



412-UA	
Material Material Matière	Fibra vulcanizada Vulcanized fiber Fibre vulcanisée
Medidas del ocular Welding glass measurements Dimension de l'oculaire	105 x 50 mm 110 x 55 mm
Tonos Shades Nuances	9 - 13
Talla atalaje Harness size Taille du harnais	→ ← 52-61cm
Norm	EN 166 EN 169 EN 175





415

Material Material Matière	Poliamida Polyamide Polyamide
Medidas del ocular Welding glass measurements Dimension de l'oculaire	105 x 50 mm 110 x 55 mm 110 X 90 mm
Tonos Shades Nuances	9 - 13
Talla atalaje Harness size Taille du harnais	 52-61cm
Norm	EN 166 EN 397 EN 169 EN 50365 EN 175



409

Material Material Matière	Poliéster y fibra de vidrio Polyester and fiberglass Polyester et fibre de verre
Medidas del ocular Welding glass measurements Dimension de l'oculaire	105 x 50 mm 110 x 55 mm 110 x 90 mm
Tonos Shades Nuances	9 - 13
Talla atalaje Harness size Taille du harnais	 52-61cm
Norm	EN 166 EN 169 EN 175

Marco ocular abatible
Adjustable glass filter plate
Cadre oculaire rabattable



415-A

Material Material Matière	Poliamida Polyamide Polyamide
Medidas del ocular Welding glass measurements Dimension de l'oculaire	105 x 50 mm 110 x 55 mm
Tonos disponibles Available shades Nuances disponibles	9 - 13
Talla atalaje Harness size Taille du harnais	 52-61cm
Norm	EN 169 EN 175 EN 397 EN 50365

409-A

Material Material Matière	Poliéster y fibra de vidrio Polyester and fiberglass Polyester et fibre de verre
Medidas del ocular Welding glass measurements Dimension de l'oculaire	105 x 50 mm 110 x 55 mm
Tonos Shades Nuances	9 - 13
Talla atalaje Harness size Taille du harnais	 52-61cm
Norm	EN 166 EN 169 EN 175

Marco ocular abatible
Adjustable glass filter plate
Cadre oculaire rabattable





» PANTALLAS DE MANO | HEAD SHIELDS | ÉCRAN MANUEL



410

Material Material Matière	Poliamida más fibra de vidrio Polyamide and fiberglass Polyamide et fibre de verre
Medidas del ocular Welding glass measurements Dimension de l'oculaire	105 x 50 mm 110 x 55 mm
Tonos Shades Nuances	9 - 13
Norm	EN 166 EN 169 EN 175



410-E

Material Material Matière	Poliamida más fibra de vidrio Polyamide and fiberglass Polyamide et fibre de verre
Medidas del ocular Welding glass measurements Dimension de l'oculaire	105 x 50 mm 110 x 55 mm
Tonos Shades Nuances	9 - 13
Norm	EN 166 EN 169 EN 175



Marco ocular deslizante
Sliding glass frame
Cadre oculaire glissement



418

Material Material Matière	Fibra de vidrio vulcanizada Vulcanized fiberglass Fibre de verre vulcanisée
Medidas del ocular Welding glass measurements Dimension de l'oculaire	105 x 50 mm 110 x 55 mm
Tonos Shades Nuances	9 - 13
Norm	EN 166 EN 169 EN 175



418-UE

Material Material Matière	Fibra de vidrio vulcanizada Vulcanized fiberglass Fibre de verre vulcanisée
Medidas del ocular Welding glass measurements Dimension de l'oculaire	105 x 50 mm 110 x 55 mm
Tonos Shades Nuances	9 - 13
Norm	EN 166 EN 169 EN 175



Marco ocular deslizante
Sliding glass frame
Cadre oculaire glissement



419

Material Material Matière	Poliéster y fibra de vidrio Polyester and fiberglass Polyester et fibre de verre
Medidas del ocular Welding glass measurements Dimension de l'oculaire	105 x 50 mm 110 x 55 mm
Tonos Shades Nuances	9 - 13
Norm	EN 166 EN 169 EN 175



419-E

Material Material Matière	Poliéster y fibra de vidrio Polyester and fiberglass Polyester et fibre de verre
Medidas del ocular Welding glass measurements Dimension de l'oculaire	105 x 50 mm 110 x 55 mm
Tonos Shades Nuances	9 - 13
Norm	EN 166 EN 169 EN 175



Marco ocular deslizable
Sliding glass frame
Cadre oculaire glissement



» **PANTALLAS FACIALES DE SOLDADURA**
| WELDING FACE SHIELD | VISIÈRES DE SOUDAGE

324-RG V

Casco | Helmet | Casque

Material Material Matière	HDPE
Medidas Size Dimensions	52-61cm
Visor Visor Visière	
Material Material Matière	Policarbonato verde Green polycarbonate Polycarbonate vert
Medidas Size Dimensions	389 x 201 x 1,5 (mm)
Marcado Marking Marquage	5 Climax 1 B C€
Norm	EN 166 EN 169 EN 175



» GAFAS PARA SOLDADURA | WELDING GOGGLES | LUNETTES DE SOUDAGE



80	
Montura Frame Monture	HDPE
Clase óptica Optical class Classe optique	1
Ocular Lenses Oculaire	Cristal inactivo de 3 mm de espesor Inactin crystal with a nominal thickness of 3 mm Verre inactinique de 3 mm d'épaisseur 
Tonos disponibles Wide ranges of shades Nuances disponibles	4 - 6
Norm	EN 166 EN 169 EN 175



545-A	
Montura Frame Monture	Vinílica con lentes abatibles Vinyl frame with adjustable lenses Vinyle avec verres relevables
Clase óptica Optical class Classe optique	1
Ocular Lenses Oculaire	Cristal inactivo de 3 mm de espesor Inactin crystal with nominal thickness of 3 mm Verre inactinique de 3 mm d'épaisseur 
Tonos disponibles Wide ranges of shades Nuances disponibles	4 - 6
Norm	EN 166 EN 169 EN 175



571 V	
Montura Frame Monture	Polycarbonato Polycarbonate Polycarbonate
Clase óptica Optical class Classe optique	1
Ocular Lenses Oculaire	Polycarbonato verde Green polycarbonate plate Polycarbonate vert
Tonos Shades Nuances	5
Norm	EN 166 EN 169 EN 175

» RECAMBIOS | SPARE PARTS | PIÈCES DE RECHANGE

Cubrefiltros Filter covers Écran de protection		
Versiones Versions Versions	Exterior Exterior Extérieur	Interior Inside Intérieur
Material Material Matière	Polycarbonato Polycarbonate Polycarbonate	
Dimensiones Field of vision Dimensions	225 x 105 mm	110 x 97 110 x 90 110 x 55 105 x 50 mm
Espesor Thickness Épaisseur	1 mm	
Clase óptica Optical class Classe optique	1	
Norm	EN 166	



Cassetes			
Versiones Versions Versions	420	421	422
Área de visión Viewing area Zone de visualisation	100 x 41 mm	100 x 52 mm	92 x 42 mm
Detectores de luz Light detectors Détecteurs de lumière	2	4	2
Tono claro Light shade Nuance claire	4		
Tonos oscuros Dark shades Nuances sombres	Variable de 9 - 13 Variable 9 - 13 Variable de 9 - 13	Variable de 5-8 / 9-13 Variable 5-8 / 9-13 Variable 5-8 / 9-13	Variable de 9 - 13 Variable 9 - 13 Variable de 9 - 13
Norm	EN 379		

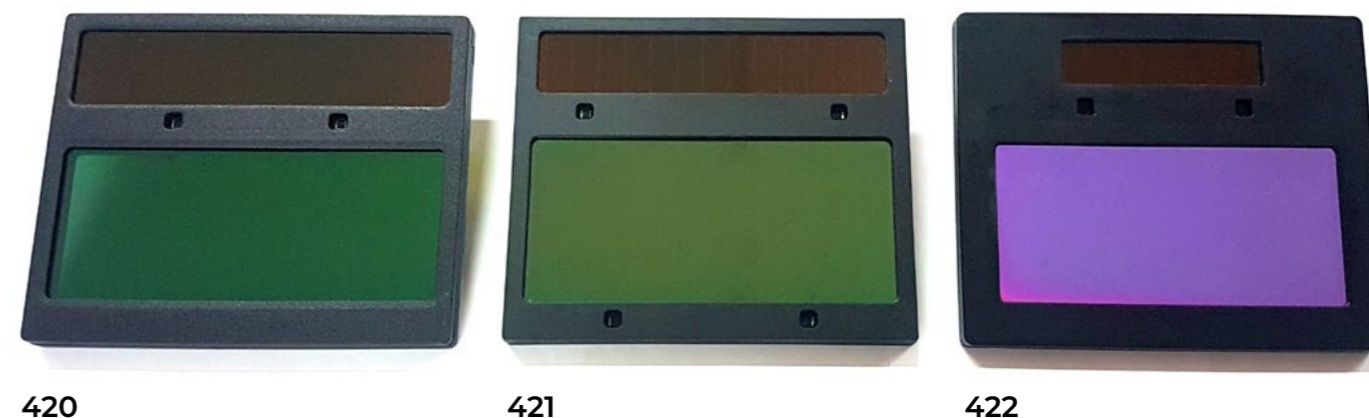

420

421

422

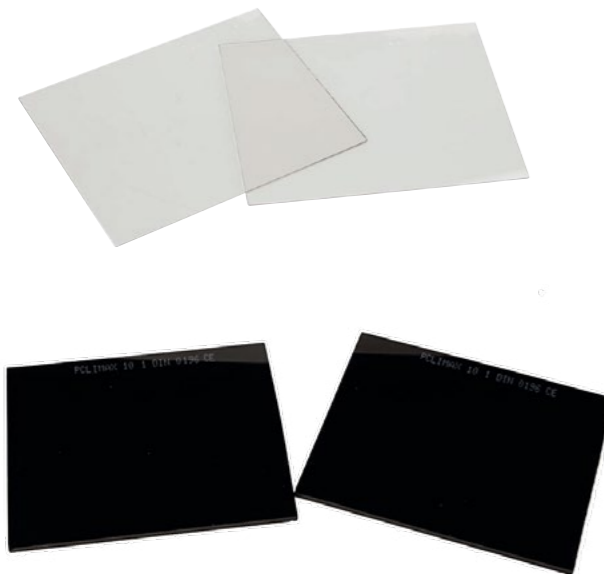

Oculares

Lenses
Verre

Versiones Versions Versions	Incoloro Colorless Incolores	Inactínico Inactinic Inactiniques
Material Material Matière	Vidrio inorgánico Inorganic glass Verre inorganique	
Dimensiones Field of vision Dimensions	105 x 50 110 x 55 110 x 90	
Tonos disponibles Wide ranges of shades Nuances disponibles		Variable de 8 a 13 Variable 8 - 13 Variable de 8 à 13
Clase óptica Optical class Classe optique	1	
Norm	EN 166	EN 169



Oculares

Lenses
Verre

Versiones Versions Versions	Incoloro Colorless Incolores	Inactínico Inactinic Inactiniques
Material Material Matière	Vidrio inorgánico Inorganic glass Verre inorganique	
Dimensiones Field of vision Dimensions	50 mm	
Tonos disponibles Wide ranges of shades Nuances disponibles		Variable de 4 a 6 Variable 4 - 6 Variable de 4 à 6
Clase óptica Optical class Classe optique	1	
Norm	EN 166	EN 169

Atalaje y deflector

Serie 324 / 425

Material Material Matière	HDPE
Medidas Size Dimensions	52-61cm



Atalaje PS Soldadura

Material Material Matière	HDPE
Medidas Size Dimensions	52-61cm





» ELECCIÓN DE FILTROS SEGÚN EL PROCESO DE SOLDADURA

| FILTER SELECTION ACCORDING TO THE WELDING PROCESS | SÉLECTION DES FILTRES EN FONCTION DE LA PROCÉDURE DE SOUDURE

Selección del tono de protección ocular según el tipo de soldadura

Selection of shade protection depending on the kind of welding
Sélection de la nuance de protection oculaire en fonction du type de soudure

	Electrodos envueltos (Fe, Cu, Ni, Al, Ag, bronce, latones y otras)	Soldaduras MIG (Fe, Cu, Ni, Al, Ag, bronce, latones y otras aleaciones)	Soldaduras MAG (Todos los aceros)	Soldaduras TIG (Fe, Cu, Ni, Al, Ag, bronce, latones y otras aleaciones)	Soldaduras de Plasma (Todos los metales soldables)
	Coated electrodes (Fe, Cu, Ni, Al, Ag and other their alloys)	MIG welding (Fe, Cu, Ni, Al, Ag and other their alloys)	MAG welding (All steels)	Soudures TIG (Fe, Cu, Ni, Al, Ag, bronzes, laitons et autres alliages)	Plasma Jet Welding (All welding metals)
	Électrodes enrobées (Fe, Cu, Ni, Al, Ag, bronzes, laitons et autres alliages)	Soudures MIG (Fe, Cu, Ni, Al, Ag, bronzes, laitons et autres alliages)	Soudures MAG (Tous les aciers)	TIG on all alloys & metals (Fe, Cu, Ni, Al, Ag and other their alloys)	Soudure au Plasma (Tous les métaux soudables)
Intensidad de corriente Welding current (Amps) Intensité de courant					
0 - 10 A	8	-	8	8	2 a / to 8
25 - 50 A	9, 10	8, 9	8, 9	9, 10	9, 11
50 - 100 A	10, 11	10	9, 10	11, 12	12
100 - 200 A	12	11, 12	11, 12	12, 13	13
200 - 300 A	13	12, 13	12, 13	13, 14	14
300 - 400 A	13	13, 14	14	14	14, 15
500 A	14	14, 15	15	14	14, 15

500 A soldadura a la llama o soldadura fuerte de los metales pesados (Tª < 450°C)	Caudal de acetileno en Litros/Hora Output of acetylene flow. Rate of acetylene Débit d'acétylène en Litres/Heure	Espesor del material a soldar en mm. Thickness for welding in mm. Épaisseur du matière à souder en mm.	Número del cristal (Tono) Shade number (Shade) Numéro du verre (Nuance)
Gas welding for bronze welds of heavy metals (Tª < 450°C)	< 40	0,5 - 1	4 - 5
	40 a / to 70		6
	70 a / to 200	1 - 2	7
500 A soudure à la flamme ou soudure forte des métaux lourds (Tª < 450°C)	200 a / to 800	2 - 9	8
	> 800	9 - 30	9

Oxicorte manual con seguimiento de un trazado	Diámetro del orificio de corte en mm Diameter of cutting jet aperture in mm Diamètre de l'orifice de coupage en mm	Número del cristal (Tono) Shade number (Shade) Numéro du verre (Nuance)
Oxy acetylene cutting flame	10 / 10	6
Oxy coupage manuel avec suivi d'un tracé	10 / 10 20 / 10	7





PROTECCIÓN AUDITIVA
HEARING PROTECTION
PROTECTION AUDITIVE

» OREJERAS | EAR MUFFS | COUVRE-OREILLES



Climax 10

Material Material Matière	ABS
Tallas Sizes Tailles	S, M, L
Norm	EN 352-1

H	M	L	SNR
29	19	14	23dB

- Espuma hipoalergénica.
Hypoallergenic foam.
Mousse hypoallergénique.
- Regulación en altura.
Height adjustment.
Réglable en hauteur.



Climax 12

Material Material Matière	ABS
Tallas Sizes Tailles	S, M, L
Norm	EN 352-1

H	M	L	SNR
29	23	17	25dB

- Regulación en altura.
Height adjustment.
Regulación en altura.
- Banda de cabeza plegable
Folding headband.
Bandeau de tête pliable.



Protector auditivo de cabeza de alta visibilidad.
High visibility ear muffs
Protecteur auditif de tête haute visibilité

Climax 14-N

Material Material Matière	ABS
Tallas Sizes Tailles	S, M, L
Norm	EN 352-1

H	M	L	SNR
31	26	17	28dB

- Regulación en altura.
Height adjustment.
Réglable en hauteur.



Climax 18-P

Material Material Matière	ABS
Tallas Sizes Tailles	S, M, L
Norm	EN 352-1

H	M	L	SNR
33	28	22	31dB

- Regulación en altura.
Height adjustment.
Réglable en hauteur.



Climax 19-P

Material Material Matière	ABS
Tallas Sizes Tailles	S, M, L
Norm	EN 352-1

H	M	L	SNR
37	29	22	32dB

- Regulación en altura.
Height adjustment.
Regulación en altura.
- Banda de cabeza plegable
Folding headband.
Bandeau de tête pliable.



» OREJERAS PARA CASCOS | HELMET EARMUFFS | COQUILLES ANTI BRUIT POUR CASQUE



17-P	
Material Material Matière	ABS
Tallas Sizes Tailles	S, M, L
Norm	EN 352-3

H	M	L	SNR
31	28	21	30dB

Protector auditivo para casco de seguridad Climax:
Ear muff for Climax safety helmet:
Protecteur auditif pour casque de sécurité Climax:

5-RS, 5-RG, Tirreno, Cadí y Curro

- Anclaje universal de 3 cm.
3 cm universal anchorage.
Ancrage universel 3 cm.
- Regulación en altura.
Height adjustment.
Regulación en altura.

5-P	
Material Material Matière	ABS
Tallas Sizes Tailles	S, M, L
Norm	EN 352-3

H	M	L	SNR
29	25	19	27dB



» TAPONES AUDITIVOS | EARPLUGS | BOULES QUIES



16-P	
Material Material Matière	ABS
Tallas Sizes Tailles	S, M, L
Norm	EN 352-3

H	M	L	SNR
29	23	17	25dB

Protector auditivo para casco de seguridad Climax:
Ear muff for Climax safety helmet:
Protecteur auditif pour casque de sécurité Climax:

5-RS, 5-RG y Tirreno

- Anclaje universal de 3 cm.
3 cm universal anchorage.
Ancrage universel 3 cm.
- Regulación en altura.
Height adjustment.
Regulación en altura.



13E	
Tapones suditivos de espuma de PU desechable. PU Foam Roll Earplugs. Bouchons auditifs en mousse PU jetables.	
Norm	EN 352-2

H	M	L	SNR
38	37	35	39dB



200 pares / caja
200 pairs / box
200 paires / boîte

13E CC	
Tapones suditivos de espuma de PU desechable. PU Foam Roll Earplugs. Bouchons auditifs en mousse PU jetables.	
Norm	EN 352-2

H	M	L	SNR
36	36	35	38dB



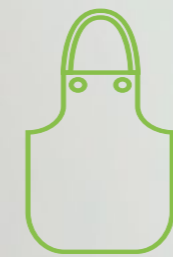

PROTECCIÓN DEL CUERPO

BODY PROTECTION

PROTECTION DU CORPS



Mandil 10

Material Material Matière	Cuero vacuno (serraje vacuno). Espesor nominal mínimo de 1 mm. Cowhide leather (cowhide split). Have a minimum nominal thickness 1 mm. Cuir bovin (croûte bovine) Fermeture velcro. Épaisseur nominale minimale de 1 mm.
Nivel de protección Protection level Niveau de protection	Clase 2 A1+A2
Tallas Sizes Tailles	Única: 60 x 90 cm One size: 60 x 90 cm Taille unique: 60 x 90 cm
Norm	EN ISO 11611:2015



Manguito 8

Material Material Matière	Cuero vacuno (serraje vacuno). Cowhide leather (cowhide split). Cuir bovin (croûte bovine).
Nivel de protección Protection level Niveau de protection	Clase 2 A1+A2
Tallas Sizes Tailles	Única: 31 cm One size: 31 cm Taille unique: 31 cm
Norm	EN ISO 11611:2015



● **Cierre velcro.**
Velcro fastening.
Fermeture velcro.



Polaina 9

Material Material Matière	Cuero vacuno (serraje vacuno). Cowhide leather (cowhide split). Cuir bovin (croûte bovine).
Nivel de protección Protection level Niveau de protection	Clase 2 A1+A2
Tallas Sizes Tailles	Única: 30 cm One size: 30 cm Taille unique: 30 cm
Norm	EN ISO 11611:2015



● **Cierre velcro.**
Velcro fastening.
Fermeture velcro.



301

Material Material Matière	Piel de serraje roja. Red split leather. Croupon rouge.
Tallas Sizes Tailles	Única: 33 cm One size: 33 cm Taille unique: 33 cm
Dexteridad Dexterity Dextérité	1
Norm	EN ISO 21420 EN 388 EN 407 EN 12477

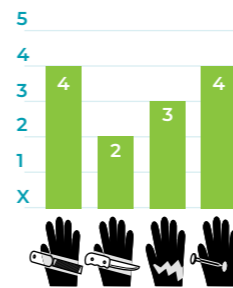
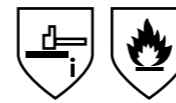

Resistencia a la inflamabilidad
Resistance to flammability
Résistance à l'inflammabilité

Resistencia al calor de contacto
Resistance to contact heat
Résistance à la chaleur de contact

Resistencia al calor de convectivo
Resistance to convective heat
Résistance à la chaleur convective

Resistencia a grandes proyecciones de metal fundido
Resistance to large projections of molten metal
Résistance aux grandes projections de métal en fusion

Resistencia a pequeñas proyecciones de metal fundido
Resistance to small projections of molten metal
Résistance aux petites projections de métal en fusion

Resistencia al calor radiante
Resistance to radiant heat
Résistance à la chaleur rayonnante

TIPO A / TYPE A / TYPE A

Resistencia a la abrasión
Abrasion resistance
Résistance à l'abrasion

Resistencia al corte por cuchilla
Blade cut resistance
Résistance à la coupure par tranchage

Resistencia al rasgado
Tear resistance
Résistance à la déchirure

Resistencia a la perforación
Puncture resistance
Résistance à la perforation





» **CONTRA SUSTANCIAS QUÍMICAS**

| AGAINST CHEMICAL SUBSTANCES | CONTRE LES PRODUITS CHIMIQUES



Mandil 10-C	
Material Material Matière	PVC laminado negro Made of PVC. PVC laminé noir.
Aplicación Application Application	Protección contra el riesgo de salpicaduras de sustancias químicas peligrosas, tales como ácidos álcalis fuertes. Designed and constructed to provide full protection against the risk of splashing from hazardous chemicals such as strong acids and alkalis. Protection contre le risque d'éclaboussures de substances chimiques dangereuses telles que acides et alcalis forts.
Resistencia del material a la permeación Permeation resistance of material Résistance des matériaux à la pénétration	Ácido clorhídrico (10%): 480 min Hidróxido sódico: 480 min Hydrochloric acid (10%): 480 min Sodium hydroxide: 480 min Ácido clorhídrico (10%): 480 min Hydroxyde de sodium: 480 min
Tallas Sizes Tailles	Única: 70 x 100 cm One size: 70 x 100 cm Taille unique: 70 x 100 cm



Mandil 10-N	
Material Material Matière	Neopreno color gris. Made of neoprene with grey cotton. Gris néoprène.
Aplicación Application Application	Protección contra el riesgo de salpicaduras de sustancias químicas tales como ácidos y álcalis fuertes. Designed and constructed to provide full protection against the risk of splashing from hazardous chemicals such as strong acids and alkalis. Protection contre le risque d'éclaboussures de substances chimiques dangereuses telles que acides et alcalis forts.
Resistencia del material a la permeación Permeation resistance of material Résistance des matériaux à la pénétration	Ácido clorhídrico (10%): 290 min Ácido sulfúrico (10%): 147 min Hidróxido sódico: 182 min Hydrochloric acid (10%): 290 min Sulfuric acid (10%): 147 min Sodium hydroxide: 182 min Ácido clorhídrico (10%): 290 min Acide sulfurique (10%): 147 min Hydroxyde de sodium: 182 min
Tallas Sizes Tailles	Única: 70 x 100 cm One size: 70 x 100 cm Taille unique: 70 x 100 cm



» **GUANTES** | GLOVES | GANTS

Labor	
Material Material Matière	Nitrilo gris en palma sobre nylon Gray nitril on palm, nylon Nitrile gris au niveau de la paume sur nylon
Tallas Sizes Tailles	S, M, L, XL
Norm	EN 388 EN 420

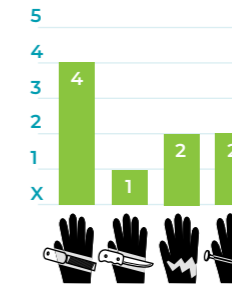

Nitrilo	
Material Material Matière	Nitrilo en palma sobre nylon Gray nitril on palm, nylon Nitrile au niveau de la paume sur nylon
Tallas Sizes Tailles	Única One size Taille unique
Norm	EN 388 EN 420

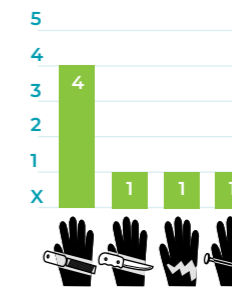

102	
Material Material Matière	Piel de serraje de vacuno forrado con algodón Cowhide split lined with cotton Peau tannée de bovin doublée en coton
Tallas Sizes Tailles	Única One size Taille unique
Dexteridad Dexterity Dextérité	2
Norm	EN 388 EN ISO 21420

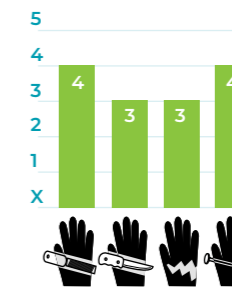

201	
Material Material Matière	Flor vacuno amarillo Yellow cow grain driver glove Fleur bovine jaune
Tallas Sizes Tailles	M, L, XL
Dexteridad Dexterity Dextérité	3
Norm	EN 388 EN ISO 21420

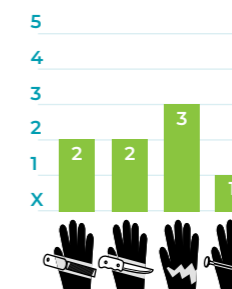

Resistencia a la abrasión
Abrasion resistance
Résistance à l'abrasion



Resistencia al corte por cuchilla
Blade cut resistance
Résistance à la coupure par tranchage



Resistencia al rasgado
Tear resistance
Résistance à la déchirure



Resistencia a la perforación
Puncture resistance
Résistance à la perforation



» FAJAS LUMBARES Y MUÑEQUERAS

| ELASTIC BELTS AND WRIST BANDS | CEINTURES LOMBAIRES ET BANDES DE POIGNET



Cierre velcro y hebilla metálica
Velcro closure and metal buckle
Fermeture velcro et boucle en métal

15-C	
Material Material Matière	Banda lumbar acolchada con espuma micro perforada y transpirable para una comodidad máxima. Semi-rigid wide waistbelt with micro-perforated and breathable foam for excellent confort. Ceinture lombaire double de mousse micro-perforée et transpirable pour un confort maximum.
Tallas Sizes Tailles	S, M, L, XL, XXL, XXXL



Cierre velcro
Velcro fastening
Fermeture velcro

16-C	
Aplicación Application Application	Protección a la cintura para realizar trabajos de elevación de cargas. Recommended for warehouse, loading or jackhammer jobs. Protection de la taille pour les travaux de levage.
Tallas Sizes Tailles	S, M, L, XL, XXL
Versión Version Version	Con tirantes / Sin tirantes With braces / Without braces Avec bretelles / Sans bretelles



Refuerzo lumbar mediante varillas
Lumbar reinforced with bars
Renforcement lombaire au moyen de tiges

Cierre velcro
Velcro fastening
Fermeture velcro

17-C	
Aplicación Application Application	Protección a la cintura para realizar trabajos de elevación de cargas. Recommended for warehouse, loading or jackhammer jobs. Disponible avec ou sans bretelles. Protection au niveau de la taille lors de la réalisation de travaux de levage de charges
Tallas Sizes Tailles	S, M, L, XL, XXL
Versión Version Version	Con tirantes / Sin tirantes With braces / Without braces Avec bretelles / Sans bretelles



18-C	
Aplicación Application Application	Cinturón anatómico y transpirable antilumbago, antivibratorio con cierre tipo velcro. Recomendado para trabajos de almacén, carga o martillo neumático. Beathable, anatomic belt lower back support. Vibration resistant. Velcro closure. Recommended for warehouse, loading or jackhammer jobs. Ceinture anatomique et transpirable anti lumbago, antivibratoire avec fermeture type velcro. Travaux en entrepôts de charge ou marteau pneumatique.
Tallas Sizes Tailles	S, M, L, XL



Cierre velcro
Velcro fastening
Fermeture velcro

19-C	
Aplicación Application Application	Cinturón anatómico y transpirable antilumbago, antivibratorio. Trabajos de almacén o carga, martillo neumático. Beathable, anatomic belt lower back support. Vibration resistant. Trabajos de almacén o carga, martillo neumático. Ceinture anatomique et transpirable anti lumbago, antivibratoire charges. Travaux en entrepôts de charge, marteau pneumatique.
Tallas Sizes Tailles	S, M, L, XL



Cierre tipo hebilla
Buckle closures
Fermeture type boucle

Muñequera	
Material Material Matière	Cinta elástica con enganche de velcro y hebilla de regulación. Elastic band with velcro fastening and adjusting buckle. Sangle élastique avec fermeture velcro et boucle de réglage.





Chaleco SV

Material
| Material |
Matière

Tejido poliéster 100%, material retrorreflectante
65% algodón, 35% poliéster.
100% polyester. Retroreflective material 65% cotton, 40% polyester.
Tissu polyester 100%, matière retro-réfléchissant 65% coton, 35% polyester.

2
CLASE
CLASS

Simple



Doble



Bolsa portaherramientas

Material
| Material |
Matière

Serraje de cuero de calidad superior.
Top grain leather.
Croûte de cuir de qualité supérieure.

Aplicación
| Application |
Application

Para trabajos en obra y de bricolaje.
For professional serious DIYers.
Pour les travaux de chantier et de bricolage.



Simple



Muñequera

Portaherramientas simple / muñequera

Material
| Material |
Matière

Poliéster
Polyester
Polyester

Longitud
| Length |
Longueur

93 - 118 cm

Carga máxima
| Maximum load |
Charge maximale

4 kg

- Diseñado para prevenir la caída de objetos.
Designed to prevent the falling of objects.
Conçu pour prévenir la chute d'objets.
- Se suministra con conector para enganchar al cinturón.
It is supplied with conector for attaching to the belt.
Fourni avec un connecteur pour attacher à la ceinture.





» **ESLINGAS** | SLINGS | ÉLINGUES



Eslingas

Eslingas de poliéster 100%. Fabricadas en distintos colores dependiendo de la carga que se le aplique. Alta resistencia. Cosidas con hilo de poliéster de alta tenacidad.

Material
| Material |
Matière

Slings made of 100% polyester in different colours depending on the load capacity. Sewn with reinforced polyester thread. High resistance.

Élingues en polyester 100%. Fabriquées en plusieurs couleurs en fonction de la charge qu'on leur applique. Cousues avec fil en polyester de haute résistance.

Ancho
| Width |
Largeur

30 - 150 cm

Norm

EN 1492-1

Coefficiente de Seguridad **7:1**
Security Coefficient
Coefficient de Sécurité

Certificadas según **EN 1492-1**
Certified according to
Certifié pour

Recta
| Straight |
Droite



M = 1

Estrangulada
| Strangled |
Étrangulée



M = 2

Paralela
| Parallel |
Parallèle



M = 0,8

Cesta
| Basket |
Nacelle
0° - 45°



β = 0 - 45°

M = 1,4

Cesta
| Basket |
Nacelle
46° - 60°



β = 46° - 60°

M = 1

Carga límite de trabajo
| Working load limit |
Limite de charge de travail

Color
| Colour |
Couleur

Anchura
| Width |
Largeur

			M = 1	M = 2	M = 0,8	M = 1,4	M = 1
1.000 kg	Violeta	30 mm	1.000	2.000	800	1.400	1.000
2.000 kg	Verde	60 mm	2.000	4.000	1.600	2.800	2.000
3.000 kg	Amarillo	90 mm	3.000	6.000	2.400	4.200	3.000
4.000 kg	Gris	120 mm	4.000	8.000	3.200	5.600	4.000
5.000 kg	Roja	150 mm	5.000	10.000	4.000	7.000	5.000

- **Longitudes:** Los cinco tipos de eslingas se fabrican con longitudes de 1 m a 10 m a intervalos de 1 m. Carga máxima superior a factor de seguridad 7:1

Lengths: The five types of slings are manufactured in lengths of 1 m to 10 m in intervals of 1 m. Maximum load greater than safety factor 7:1

Longueurs : Les cinq types d'élingues sont fabriquées dans des longueurs allant de 1 m à 10 m à intervalles de 1 m. Charge maximale supérieure au facteur de sécurité 7 : 1

» **CINTA TRINCAJE PARA CARGA DE VEHÍCULOS**
| WEB LASHING ROAD VEHICLES / SANGLE D'ARRIMAGE POUR CHARGE DE VÉHICULES

25 mm

Material Material Matière	100% poliéster 100% polyester 100% polyester
Coefficiente de seguridad del equipo Safety factor of equipment Coefficient de sécurité de l'équipement	2:1
Norm	EN 12195-2

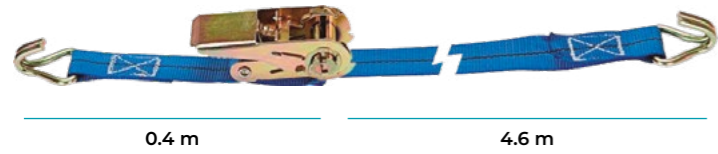

Ratchet
Ratchet
Encliquetage

50 mm

Material Material Matière	100% poliéster 100% polyester 100% polyester
Coefficiente de seguridad del equipo Safety factor of equipment Coefficient de sécurité de l'équipement	2:1
Norm	EN 12195-2



Ratchet
Ratchet
Encliquetage



Carga de trabajo
Workload
Charge de travail

25mm (LC): 1.000 Kg
50mm (LC): 4.000 Kg



Carga de trabajo
Workload
Charge de travail

25mm (LC): 2.000 Kg
50mm (LC): 8.000 Kg

» **SEÑALES DE SEGURIDAD** | SAFETY SIGNS & SYMBOLS | SIGNAUX DE SÉCURITÉ

Señales de seguridad

Safety signs

Signaux de sécurité

Material Material Matière	Señales serigrafiadas sobre planchas de PVC blanco de 0,6 mm de espesor nominal. Silk-screen printed signs on white PVC sheets with nominal thickness 0.6 mm. Signaux gravés sur des planches en PVC blanc de 0,6 mm d'épaisseur nominale.
Tamaño de las señales Sign size Dimensions des signaux	220 x 300 mm
Tamaño mural Construction signboard size Dimensions murale	700 x 1000 mm

ES OBLIGATORIO SEGUIR TODAS LAS NORMAS DE SEGURIDAD



PROHIBIDO EL PASO A TODA PERSONA AJENA A LA OBRA

Mural especial para obra
Construction signboard
Panneau mural spécial chantier



Señales de obligación
Mandatory signs
Signaux d'obligation



Señales de advertencia
Warning signs
Signaux d'avertissement



Señales de prohibición
Prohibition signs
Signaux d'interdiction

Señales lucha contra incendios
Fire safety signs
Signaux de lutte contre les incendios



Setas protectoras

Material Material Matière	Poliétileno Polyethylene Polyéthylène
Diámetro Diameter Diamètre	12 - 24 mm

Diseñadas y fabricadas según Real Decreto 485/1997 de 14 de abril: Disposiciones mínimas en materia de señalización de seguridad y salud en el trabajo.

Designed and manufactured as per Spanish Royal Decree 485/1997 of 14 april: Minimum regulations relating to health and safety signs in the workplace.

Conçues et fabriquées conformément au Décret Royal 485/1997 du 14 de avril: Dispositions minimales en matière de sécurité et de santé au travail.



Pol. Ind. Sector Mollet, C/ Llobregat nº1
Parets del Vallès
(Barcelona, España) 08150
Tel: +34 93 562 13 11
www.productosclimax.com
info@productosclimax.com

